



**DeckWise<sup>®</sup>.com**

**MANUFACTURERS OF HIDDEN DECK FASTENERS & ACCESSORIES**

Technical Data • Installation Guides • Product Specifications

**SMART SOLUTIONS FOR TOUGH DECKS.<sup>™</sup>**

**CONTACT: 941-896-9851**

**WWW.DECKWISE.COM**

## ABOUT OUR COMPANY

Since 2000, the Ipe Clip® Fastener Company (Now known as DeckWise®) has manufactured state-of-the-art deck fasteners in the US for exotic hardwoods and composite decking. With a proven track record of high customer satisfaction, every item we sell is comprised of high-grade long-lasting materials and expertly engineered to withstand the elements and corrosion better than other products on the market.

When installed, all Ipe Clip® hidden deck fasteners help to eliminate many common decking problems and are up to 3X stronger than other brands on the market. By offering products like the Hardwood Wrench™, Ipe Oil™, Ipe Seal™, and other essential decking tools and accessories, we've got you covered.

From the time our company was founded, every year has brought extensive growth. With every innovative product that we bring to the market, we continue to expand our worldwide network of dealers and distributors whose main goal is to provide their customers with the best decking tools and accessories.

# DeckWise.com



## OUR COMPANY HISTORY

**2000** - With most hardwood deck fasteners on the market at the time being met with poor reviews and customer complaints, the need for a quality deck fastener was apparent. The first Ipe Clip® hidden deck fastener is developed and tested to show that a deck fastener/clip could withstand the harshest of applications, most dense wood and climate changes.

**2001** - The soon-to-be Ipe Clip Fastener Co, LLC, applied for their first of many patents with the United States Patent and Trademark Office.

**2002** - The Ipe Clip® Fastener Company is born and has its first sales with astounding reviews. Finally, the hardwood market has a hidden deck fastener that can deliver on its promise of quality, strength, and longevity.

**2003** - Sales grow dramatically as deck builders and DIY homeowners rave about the easy installation and superior hold-down strength of the Ipe Clip® hidden deck fastener.

**2004** - Ipe Clip® expands its distribution network and grows to become a worldwide brand. International distributors start to inquire about carrying and promoting the product. While Ipe Clip® deck fasteners are quickly becoming the top choice of contractors and home owners alike; the desire to improve and expand the product line still exists. Development and testing begins for air-dried hardwood deck fasteners; the Ipe Clip® Extreme™.

**2005** - The Ipe Clip® Extreme™ is released and the feedback is nothing short of amazing. The polymer molded fasteners now have a stainless steel insert adding up to 3X the strength over other brands. The general consensus from deck building experts is, that, the Ipe Clip® Fastener Company delivered what every deck builder dreamed about. It's as close to a perfect fastener as anyone could achieve. Astonishing increases in sales promptly followed.

**2006** - Ipe Clip® ExtremeKD™ was developed and released to help fill the need to properly fasten kiln-dried hardwood lumber. This fastener also solved the problems many contractors faced with composite decking, especially with ¼" gap spacing and the "mushrooming" effect caused by face screwing. The Extreme™ family of fasteners has surpassed even the hopes and projections of the Ipe Clip® Fastener Company; they have already become much more popular than the Standard Ipe Clip® fastener that was released just six years ago.

**2007** - In an effort to keep up with demand, the Ipe Clip® Fastener Company expands to a larger facility in South Carolina. Their new warehouse is over 10 times larger than the previous one, which signifies a major growth spurt for such a young company.

**2008** - Product research and development begins on new deck tools and accessories which will pave the way for what is expected to be a booming 2009.

**2009** - It would appear that all the research done in 2008 had really paid off; three new products are unveiled to the decking industry. First, the Hardwood Wrench™ steals the spotlight at the International Builders Show. Builders, contractors, and engineers all rave at the clip design and power of this new board straightening tool. Ipe Oil™ hardwood deck finish is the next product to be released. Its ability to soak into hardwoods such as Ipe makes it an easy choice for deck builders and DIY home owners when it came to protecting their decks. Finally, with Extreme Plugs™, countersinking screws is easier than ever. Tolerance absorbing rings cut into the plugs were an industry first and solved a major problem that most builders had when it came to traditional wood plugs. It came as no surprise to anyone, that, the folks at the Ipe Clip® Fastener Company were continuing to introduce innovative solutions and products to the marketplace.

**2010** - Ipe Clip® Extreme4™ is officially introduced into the market as the best hidden deck fastener. It is designed to work perfectly with air-dried decking, kiln-dried hardwoods, and both composite and PVC decking materials. This fastener not only works well with most decking materials - which is by far its most appealing characteristic - but when it's added to the already well known Extreme™ family of fasteners, builders finally have a choice between which fastener to use and what gap spacing they desire.

**2011** - Spurred by continued growth, The Ipe Clip Fastener Co, LLC moves to a new 70,000 s.f. facility in Bradenton Florida. New machinery is purchased for manufacturing more fasteners, more wrenches and now the steel inserts are coated with black oxide to assist with hiding the fastener screw heads in between gaps. More new products are unleashed such as the introduction of the Deck Tile Connector System and the new Drill & Drive 3-in-1 interchangeable drill bit and drive head for faster fastener installations. Deck board gap spacers and hidden hardwood siding fasteners soon followed.

**2012** - The Ipe Clip® Fastener Co., LLC, changes its' name to better service the decking industry with a packed portfolio of products. Branded in the US as DeckWise®, and internationally as DeckWise® B.V., an entire new corporate ID was hatched through many new marketing efforts including the new website at [www.DeckWise.com](http://www.DeckWise.com). Under the mantra "Smart Solutions For Tough Decks," we strive to be a one-stop-shop around the globe.

**2013** - DeckWise® continues to be innovative in the decking industry always exploring new ways to make stronger, longer-lasting decks. This year the addition of new decking screw lines thrust the company further ahead as a leader.

**2014** - The reason why we have enjoyed such success is because of the great partnerships we have created by our network of distributors. 2014 ushers in more new product ideas and concepts that will surely beam brightly in the years to come. By creating the most innovative decking products on the market today, and by ensuring that our distributors have access to these products in a fast and efficient manner, DeckWise® is here to stay... and grow.



# Table Of Contents

Deckwise®, an Ipe Clip® Fastener Company, LLC., manufactures patented hidden deck fasteners for exotic hardwood, composite, and PVC decking at our US facility in Bradenton Florida. Our flagship Extreme™ line of hidden deck fasteners, allow for fast installations while giving a professionally finished, smooth and elegant look.

The DeckWise® line of deck-building products range from stainless steel deck screws, a board straightening tool, deck board gap spacers, hardwood plug kits, 3-in-1 drilling tool, hardwood deck finish, an end grain sealant, as well as hidden siding fasteners. DeckWise® offers an all-in-one source for everyone's complete deck building needs.

- 2 About Our Company
- 4 Installation Photos
- 5 DeckWise® Extreme™ Hidden Deck Fastener Specifications
- 6 - 7 Advantages to Hidden Deck Fasteners, Coverage & Groove Profile
- 8 - 9 DeckWise® Extreme™ Fastener System
- 10 - 11 DeckWise® Extreme4™ Fastener System
- 12 - 13 DeckWise® ExtremeKD™ Fastener System
- 14 - 15 DeckWise® Standard Fastener System
- 16 - 17 Ipe Clip® Hidden Deck Fastener Installation Process
- 18 - 19 Installation: Hardwoods vs. Composite/PVC Decking
- 20 Board Replacement Step by Step Process
- 21 Hidden Deck Fasteners vs. Face Screwing Price Comparison
- 22 - 23 Fastener Uplift & Salt Spray Testing
- 24 - 25 Colormatch #8 & #10 Stainless Steel Deck Screws
- 26 - 27 Heat-Treated Deck Screws & Self-Tapping Metal Joist Deck Screws
- 28 - 29 Composite Deck Screws & Hardwood Plug Kits
- 30 - 31 Ipe Oil™ Hardwood Deck Finish by DeckWise®
- 32 - 33 Ipe Seal™ End Grain Sealant by DeckWise®
- 34 - 35 Hidden Siding Fastener Kits
- 36 - 37 DeckWise® Deck Tile Systems & Connectors
- 38 DeckWise® Hardwood Wrench™ Board Straightening Tool
- 39 DeckWise® Drill & Drive™ & Deck Board Gap Spacers
- 40 - 41 DeckWise® Deck Board Gap Spacers & DeckWise® Joist Tape™



Having an in-house team of engineers, designers, machinists, mold makers, and experts at our state-of-the-art manufacturing facility in Bradenton, FL, gives us a leading edge in creating and designing the best deck building products on the market. We continue testing and improving every product we put our name on. If it says by DeckWise® — you know you're using the best there is.



## Manufacturing decking solutions...

Exclusive private co-brand labeling programs are available for dealers & distributors on select DeckWise® decking products. Call 866-427-2547 for complete details.

**DeckWise**.com

# DeckWise<sup>®</sup>.com

Manufacturers of Hidden Deck Fasteners & Accessories



**1** Composite Decking installed with DeckWise<sup>®</sup> Extreme4<sup>™</sup> hidden deck fastener system.

**2** DeckWise<sup>®</sup> Extreme<sup>™</sup> fasteners used in a vertical application on this hardwood entryway.

**3** Beautiful hardwood stairs fastened down by DeckWise<sup>®</sup> Standard fasteners.

**4** Ipe decking installed over water with the use of DeckWise<sup>®</sup> ExtremeKD<sup>™</sup> fasteners.

**5** Poolside deck fastened using DeckWise<sup>®</sup> ExtremeKD<sup>™</sup> fasteners.

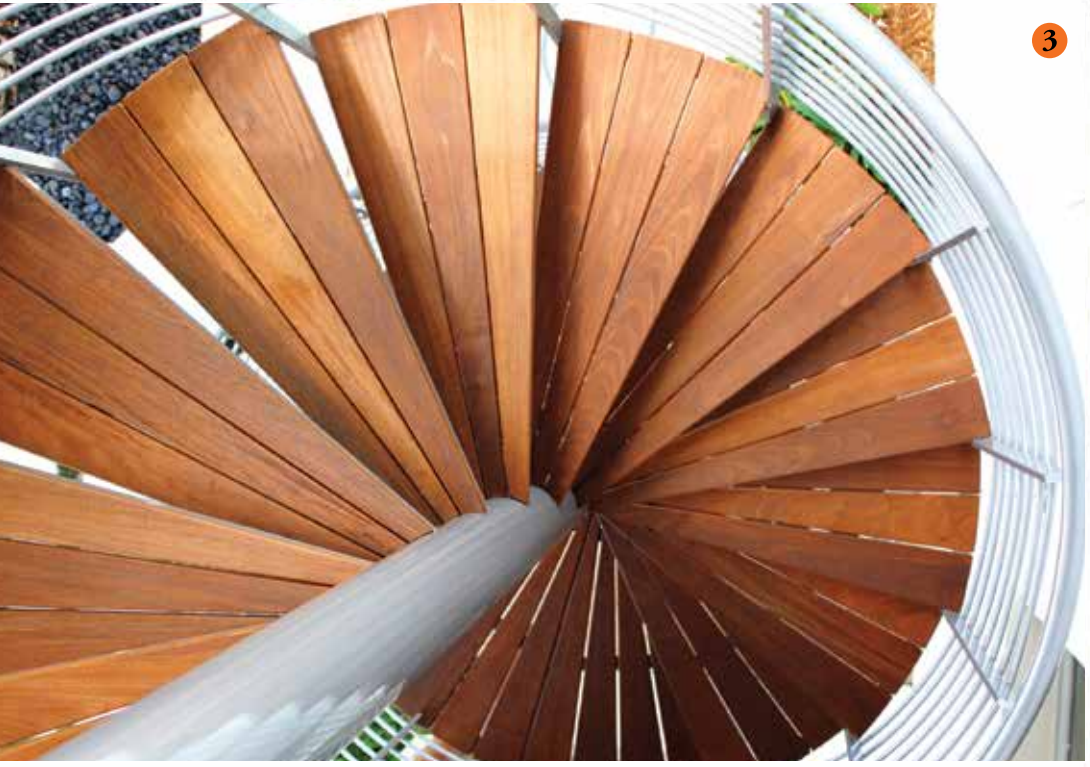



# Ipe Clip®

Hidden Deck Fasteners

Manufactured By DeckWise®



## Air-Dried Lumber & Composites

### EXTREME™

Provides maximum holding strength in extreme hot or cold, humid or dry climates.

3/32" Gap Spacing (2.38mm)

Ipe Clip® Extreme™ Fastener Features Quick Guide:



Automatic Gap Spacing



Black Oxide Stainless Steel Insert Molded Inside

Short leg height = .250" (6.35 mm)

Tall leg height = .375" (9.5 mm)

Available in our 3 signature colors to match decking.



## Air-Dried Lumber, Kiln-Dried Lumber, & Composites

### EXTREME4™

To simplify the deck installation process the Extreme4™ fastener can be used to fasten almost any decking board.

5/32" Gap Spacing (4.0mm)

Ipe Clip® ExtremeKD™ Fastener Features Quick Guide:



Collapsible Legs Automatic Gap Spacing



Black Oxide Stainless Steel Insert Molded Inside



Gap Spacer Required During Installation

Short leg height = .250" (6.35mm) ONLY

Available in our 3 signature colors to match decking.



## Kiln-Dried Lumber, Composites & PVC

### EXTREMEKD™

Hollow leg is ideal for expansion of kiln dried decking materials. The 1/4" Leg spacer accommodates composite decking requirements.

1/4" Gap Spacing (6.35mm)

Ipe Clip® Extreme4™ Fastener Features Quick Guide:



Collapsible Legs Automatic Gap Spacing



Black Oxide Stainless Steel Insert Molded Inside



Gap Spacer Required During Installation

Short leg height = .250" (6.35mm) ONLY

Available in our 3 signature colors to match decking.



## Economical Alternative

### STANDARD

Fiberglass reinforced polyethylene for a stronger, all-plastic fastener

3/32" Gap Spacing (2.38mm)

Ipe Clip® Standard Fastener Features Quick Guide:



Automatic Gap Spacing



Round Shape

Short leg height = .250" (6.35mm)

Tall leg height = .375" (9.5mm)

Available in our 3 signature colors to match decking.

# Ipe Clip®

## Hidden Deck Fasteners

Manufactured By DeckWise®



### Stainless Steel Insert



Corrosion resistant, black oxide stainless steel insert increases hold down strength and eases installation by helping to prevent over-driving of screws.

### Gap Spacing

Our line of deck fasteners offer a vast array of gap spacing options. Whether installing air or kiln dried hardwood, thermally modified softwood, composite or PVC decking, we have the appropriate fastener with at least three different gap spacing options for your particular decking.

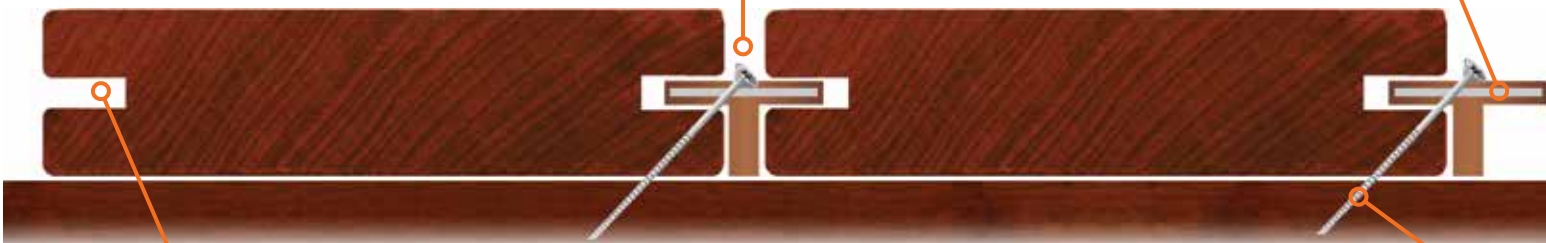

### Positioning Decking Grooves

Symmetrical groove profile allow boards to be reversed and/or flipped to put the best side up.



### Cutting Decking Grooves

Many lumber yards now offer pregrooved materials in stock.

**-OR-**

Cut the groove yourself using a standard biscuit joiner or router with a 5/32" slot cutter.



### Screws Driven at a 45° Angle

Ability to run screws at a 45 degree angle through hardwoods greatly increases hold-down strength. Studies have proven that screws have more holding strength when ran on an angle. This method also maintains even gap spacing while properly allowing boards to expand and contract with the seasons.

These products are protected under one or more of the following patents; D485,160; 8,464,488; Other Patents Pending, and/or D470,039 product is licensed under U.S. Patent No. 6,402,415

## Why a plastic coating over a steel insert?

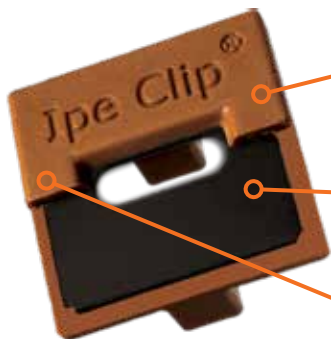

Unlike most all-metal hidden deck fasteners, which can react with wood causing staining, the Ipe Clip® is molded of a malleable plastic polymer resin coating (further adding UV & chemical resistant qualities), allowing for the natural expansion/contraction of wood decking.

Our rigid stainless steel insert firmly holds decking to joists (up to 3X more hold-down strength than other edge-mount deck fasteners), eliminating decking screws from pulling through as the deck material expands.

Designed for exotic hardwoods, the color of the plastic resin also works to further camouflage and conceal our fasteners between the board gaps for a more sleek, upscale surface.

# DeckWise® Hidden Deck Fastener Approximate Coverage

Approximate coverage for 100 Count Kit of DeckWise® fasteners

Joist Spacing	Width of Deck Boards	
	3½"	5½"
24"	50 ft²	100 ft²
16"	36 ft²	57 ft²
12"	25 ft²	50 ft²

Approximate coverage for Full 175 Count Kit of DeckWise® fasteners

Joist Spacing	Width of Deck Boards	
	3½"	5½"
24"	87 ft²	175 ft²
16"	63 ft²	100 ft²
12"	44 ft²	87 ft²

## Decking Groove Profile



A = 5/32" (4mm)

B = 1/2" (13mm)

C = Measurement of the deck board thickness being installed.

D = (C-A)/2 *Note: this will center the groove in the board*

### 1x6 Example

Let's say you are installing 1x6 decking, that would mean that:

C = 3/4"

D = (3/4"-5/32")/2

D = (19/32")/2

D = 19/64" (7.54mm)

### 5/4x6 Example

Let's say you are installing 5/4x6 decking, that would mean that:

C = 1"

D = (1"-5/32")/2

D = (27/32")/2

D = 27/64" (10.72mm)

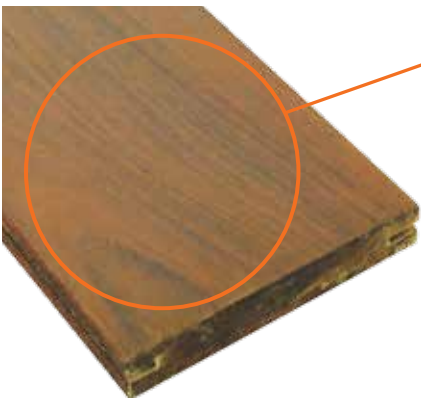

### Flawless Deck Surface

When DeckWise® hidden deck fasteners are used for the installation of a deck, a flawless surface can be achieved that is free of any ugly nail and/or screw heads.



### Decking Grooves

Whether using pregrooved decking or having the slots cut on the job site, DeckWise® hidden deck fasteners fit perfectly into the groove with plenty of tolerance to allow for an easy installation.

## DeckWise® Line of Ipe Clip® Hidden Deck Fasteners Gap Spacing

DeckWise® Hidden Deck Fasteners Standard

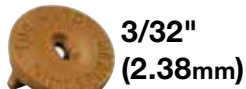

DeckWise® Hidden Deck Fasteners Extreme™



DeckWise® Hidden Deck Fasteners Extreme4™



DeckWise® Hidden Deck Fasteners ExtremeKD™



Smallest Gap Spacing at Time of Installation

Largest Gap Spacing at Time of Installation



Manufactured By DeckWise®

### Use With Exotic Hardwoods, Thermally Modified Softwoods & Composite Decking.



Hardened stainless steel insert with a black oxide coating inside rigid UV and chemical-resistant polypropylene.

Smaller leg maintains a perfect gap when materials contract due to environmental conditions.

#### Features:

- Automatically spaces deck boards at 3/32" (2.38mm)
- Manufactured from polypropylene with stainless steel; black oxide insert
- For use with air dried hardwood, composite, or PVC decking
- Allows for contraction of width of air dried hardwoods
- Allows movement of length with composite/PVC decking
- Unique design allows for more tolerance in grooved side profile while increasing hold-down area
- UV resistant
- Limited Lifetime Warranty

#### Fastener Dimensions

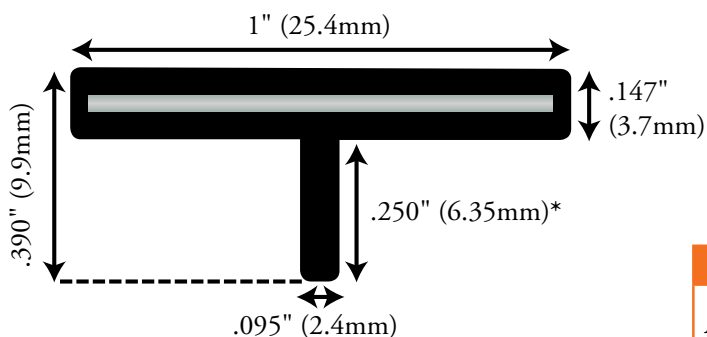

Clip Construction		
Material	Stainless Steel Insert	Available Colors
Polypropylene/ Fiberglass	.883" x .883" Thickness: .036"	

\*Short version shown above  
Tall version = .375" (9.5 mm)

Decking Compatibility		
Air-Dried Decking	Kiln-Dried Decking	Composite/ PVC Decking
✓	✗	✓

### Allows Contraction on the Width of Air-Dried Lumber



The method of 45 degree screws hold the decking tight to the joist, while allowing one side of the deck board to remain free to contract and expand.

### Allows Expansion/Contraction Along the Length of Composite/PVC Decking



Running screws straight down with composite/PVC decking allows these materials to naturally move on their length.



## DeckWise® Extreme™ Installation Specifications

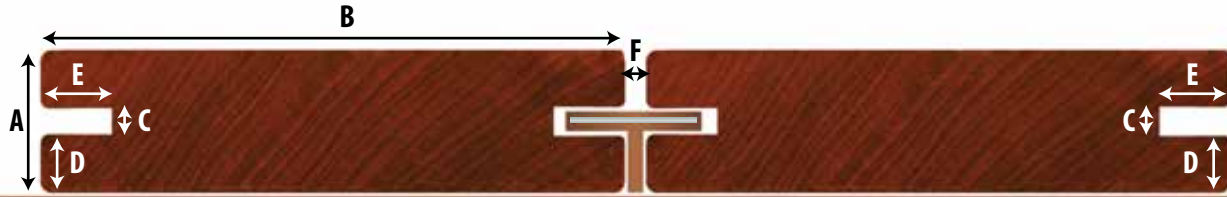

Board Dimensions		Groove Dimensions			Board Spacing
<b>Board Thickness</b>	<b>Board Width</b>	<b>Thickness of Cut</b>	<b>Cutting Height</b>	<b>Cutting Depth</b>	<b>During Installation</b>
<b>A*</b> = Measurement Of Your Decking	<b>B**</b> = Measurement Of Your Decking	<b>C</b> = 5/32"(4mm)	<b>D***</b> = (A-5/32")/2	<b>E</b> = 1/2"(13mm)	<b>F****</b> = 3/32" (2,38mm)

\* If using 1-1/2" or thicker material, you may need to upgrade to a longer screw option than what is typically packaged with the fastening kit.

\*\* For decking 8" or wider, the (A) dimension should be at least 1-1/2". Using a wide plank such as this for surface decking will most likely cause cupping issues regardless of how the material is fastened if thicker material is not used.

\*\*\* This formula will create a symmetrical profile that allows you to flip and/or rotate the decking to be able to put the best side up.

\*\*\*\* Fastener automatically achieves correct gap spacing when boards are pushed tight during installation.

### Complete Kit Contains

- (175) IPE CLIP® Extreme™ Hidden Deck Fasteners
- (190) #8x2" Colormatch Black Stainless Steel Star Drive Screws
- (12) 3/8" Tapered Ipe Plugs
- (1) 1/8" High Speed Drill Bit
- (1) T15 Star Drive Tip
- (1) Instruction Sheet

### 100 Ct. Kit Contains

- (100) IPE CLIP® Extreme™ Hidden Deck Fasteners
- (100) #8x2" Colormatch Black Stainless Steel Star Drive Screws
- (1) Instruction Sheet

### 2 Gal. Contractor Bucket

- (525) Hidden Deck Fasteners
- (565) Stainless Steel Deck Screws
- (3) T15 Star Drive Tips
- (3) 1/8" High Speed Drill Bits
- (1) Instruction Sheet

### 5 Gal. Contractor Bucket

- (1050) Hidden Deck Fasteners
- (1130) Stainless Steel Deck Screws
- (5) T15 Star Drive Tips
- (5) 1/8" High Speed Drill Bits
- (1) Instruction Sheet



Coverage varies, see coverage page in this manual.





Manufactured By DeckWise®

### Use With Exotic Hardwoods, Thermally Modified Softwoods & Composite Decking.



Hardened stainless steel insert with a black oxide coating inside UV and chemical-resistant polyethylene.

Versatile leg is compatible with most decking materials.

#### Features:

- Automatically spaces deck boards at 5/32" (4mm)
- Manufactured from polyethylene with stainless steel; black oxide insert
- For use with air/kiln dried hardwood, composite, or PVC decking
- Allows for contraction of width of air dried hardwoods
- Allows for expansion of width of kiln dried hardwoods
- Allows movement of length with composite/PVC decking
- Unique design allows for more tolerance in grooved side profile while increasing hold-down area
- UV resistant • Limited Lifetime Warranty

#### Fastener Dimensions

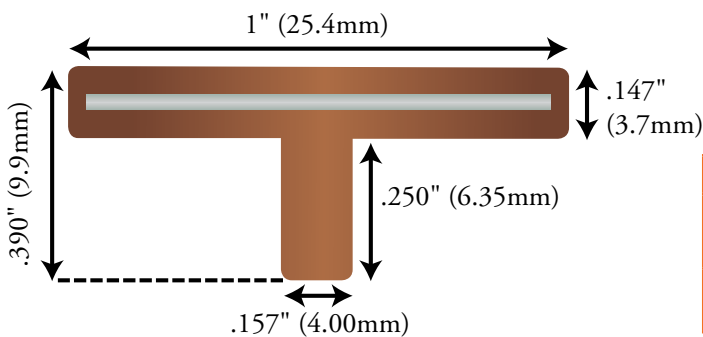

Clip Construction		
Material	Stainless Steel Insert	Available Colors
Polyethylene	.883" x .883" Thickness: .036"	

Decking Compatibility		
Air-Dried Decking	Kiln-Dried Decking	Composite/ PVC Decking
✓	✓	✓

### Allows Contraction on the Width of Air-Dried Lumber



The method of 45 degree screws hold the decking tight to the joist, while allowing one side of the deck board to remain free to contract.

### Allows Expansion on the Width of Kiln-Dried Lumber



The method of 45 degree screws hold the decking tight to the joist, while allowing one side of the deck board to remain free to expand.

### Allows Expansion/Contraction Along the Length of Composite/PVC Decking



This illustrates how the composite decking moves on its length.

Running screws straight down with composite/PVC decking allows these materials to naturally move on their length.

## DeckWise® Extreme4™ Installation Specifications

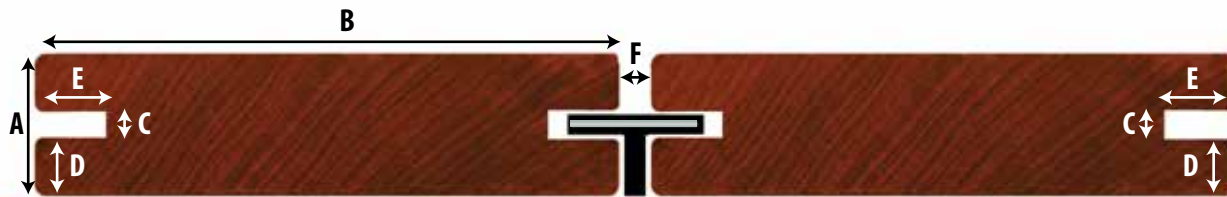

Board Dimensions	
Board Thickness	Board Width
A* = Measurement Of Your Decking	B** = Measurement Of Your Decking

Groove Dimensions		
Thickness of Cut	Cutting Height	Cutting Depth
C = 5/32" (4mm)	D*** = (A-5/32")/2	E = 1/2" (13mm)

Board Spacing
During Installation
F**** = 5/32"(4,00mm)

\* If using 1-1/2" or thicker material, you may need to upgrade to a longer screw option than what is typically packaged with the fastening kit.

\*\* For decking 8" or wider, the (A) dimension should be at least 1-1/2". Using a wide plank such as this for surface decking will most likely cause cupping issues regardless of how the material is fastened if thicker material is not used.

\*\*\* This formula will create a symmetrical profile that allows you to flip and/or rotate the decking to be able to put the best side up.

\*\*\*\* Fastener automatically achieves correct gap spacing when boards are pushed tight during installation.

- Complete Kit Contains**
- (175) IPE CLIP® Extreme4™ Hidden Deck Fasteners
  - (190) #8x2" Colormatch Black Stainless Steel Star Drive Screws
  - (12) 3/8" Tapered Ipe Plugs
  - (1) 1/8" High Speed Drill Bit
  - (1) T15 Star Drive Tip
  - (3) 5/32" Spacer Tools
  - (1) Instruction Sheet

- 100 Ct. Kit Contains**
- (100) IPE CLIP® Extreme4™ Hidden Deck Fasteners
  - (100) #8x2" Colormatch Black Stainless Steel Star Drive Screws
  - (1) Instruction Sheet
  - (3) 5/32" Spacer Tools



5/32" (4mm) Spacer Tool Included



Coverage varies, see coverage page in this manual.

- 2 Gal. Contractor Bucket**
- (525) Hidden Deck Fasteners
  - (565) Stainless Steel Deck Screws
  - (6) 5/32" Spacer Tools
  - (3) T15 Star Drive Tips
  - (3) 1/8" High Speed Drill Bits
  - (1) Instruction Sheet

- 5 Gal. Contractor Bucket**
- (1050) Hidden Deck Fasteners
  - (1130) Stainless Steel Deck Screws
  - (6) 5/32" Spacer Tools
  - (5) T15 Star Drive Tips
  - (5) 1/8" High Speed Drill Bits
  - (1) Instruction Sheet



#8x2" Colormatch Black Stainless Steel Star Drive Screws



3/8" Tapered Ipe Plugs



1/8" High Speed Drill Bit



T15 Star Driver Tip



Manufactured By DeckWise®

## Use With Exotic Hardwoods, Thermally Modified Softwoods & Composite Decking.



Hardened stainless steel insert with a black oxide coating inside UV and chemical-resistant polyethylene.

Hollow leg acts as a shock absorber as kiln-dried materials expand.

### Features:

- This system automatically spaces deck boards at 1/4" (6.35mm)
- Manufactured from polyethylene with stainless steel; black oxide insert
- For use with kiln dried hardwood, composite, or PVC decking
- Allows for expansion of width of kiln dried hardwoods
- Allows movement of length with composite/PVC decking
- Unique design allows for more tolerance in grooved side profile while increasing hold-down area
- UV resistant
- Limited Lifetime Warranty

### Fastener Dimensions

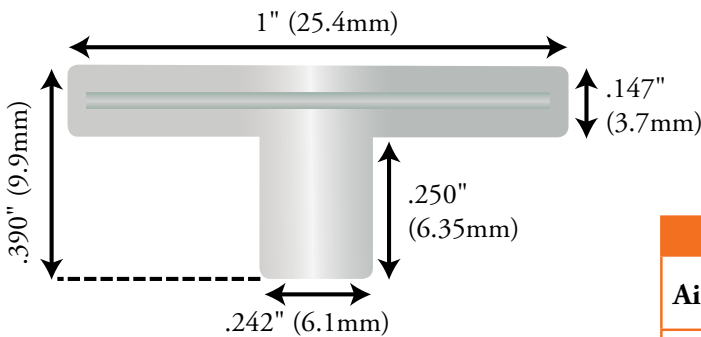

Clip Construction		
Material	Stainless Steel Insert	Available Colors
Polyethylene	.883" x .883" Thickness: .036"	

Decking Compatibility		
Air-Dried Decking	Kiln-Dried Decking	Composite/ PVC Decking
✗	✓	✓

## Allows Expansion on the Width of Kiln-Dried Lumber



The method of 45 degree screws hold the decking tight to the joist, while allowing one side of the deck board to remain free to expand.

## Allows Expansion/Contraction Along the Length of Composite/PVC Decking



Running screws straight down with composite/PVC decking allows these materials to naturally move on their length.

## DeckWise® ExtremeKD™ Installation Specifications

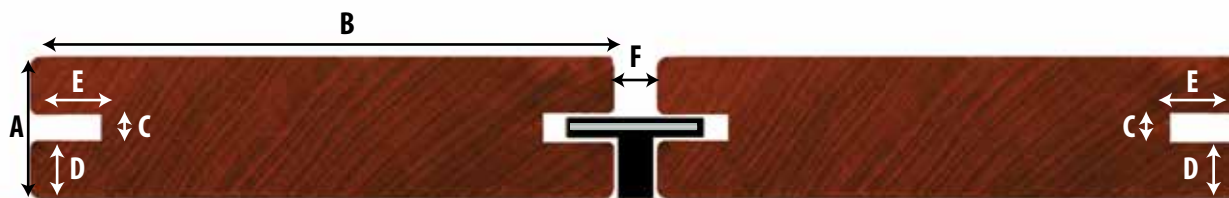

Board Dimensions	
<b>Board Thickness</b>	<b>Board Width</b>
<b>A*</b> = Measurement Of Your Decking	<b>B**</b> = Measurement Of Your Decking

Groove Dimensions		
<b>Thickness of Cut</b>	<b>Cutting Height</b>	<b>Cutting Depth</b>
<b>C</b> = 5/32" (4mm)	<b>D***</b> = (A-5/32")/2	<b>E</b> = 1/2" (13mm)

Board Spacing
<b>During Installation</b>
<b>F****</b> = 1/4" (6,35mm)

\* If using 1-1/2" or thicker material, you may need to upgrade to a longer screw option than what is typically packaged with the fastening kit.

\*\* For decking 8" or wider, the (A) dimension should be at least 1-1/2". Using a wide plank such as this for surface decking will most likely cause cupping issues regardless of how the material is fastened if thicker material is not used.

\*\*\* This formula will create a symmetrical profile that allows you to flip and/or rotate the decking to be able to put the best side up.

\*\*\*\* Fastener automatically achieves correct gap spacing when boards are pushed tight during installation.

### Complete Kit Contains

- (175) IPE CLIP® ExtremeKD™ Hidden Deck Fasteners
- (190) #8x2" Colormatch Black Stainless Steel Star Drive Screws
- (12) 3/8" Tapered Ipe Plugs
- (1) 1/8" High Speed Drill Bit
- (1) T15 Star Drive Tip
- (3) 1/4" Spacer Tools
- (1) Instruction Sheet

### 100 Ct. Kit Contains

- (100) IPE CLIP® ExtremeKD™ Hidden Deck Fasteners
- (100) #8x2" Colormatch Black Stainless Steel Star Drive Screws
- (3) 1/4" Spacer Tools
- (1) Instruction Sheet



1/4" Spacer Tool Included

### 2 Gal. Contractor Bucket

- (525) Hidden Deck Fasteners
- (565) Stainless Steel Deck Screws
- (6) 1/4" Spacer Tools
- (3) T15 Star Drive Tips
- (3) 1/8" High Speed Drill Bits
- (1) Instruction Sheet

### 5 Gal. Contractor Bucket

- (1050) Hidden Deck Fasteners
- (1130) Stainless Steel Deck Screws
- (6) 1/4" Spacer Tools
- (5) T15 Star Drive Tips
- (5) 1/8" High Speed Drill Bits
- (1) Instruction Sheet



Coverage varies, see coverage page in this manual.



#8x2" Colormatch Black Stainless Steel Star Drive Screws



3/8" Tapered Ipe Plugs



1/8" High Speed Drill Bit



T15 Star Driver Tip



Manufactured By DeckWise®

**Use With Exotic Hardwoods, Thermally Modified Softwoods  
& Composite Decking.**



**Features:**

- Automatically spaces deck boards at 3/32" (2.38mm)
- Manufactured from glass-filled polypropylene
- For use on air dried hardwood, composite, or PVC decking
- Allows for contraction of width of air dried hardwoods
- Allows movement of length with composite/PVC decking
- Unique design allows for more tolerance in grooved side profile while increasing hold-down area
- UV resistant
- Limited Lifetime Warranty
- No steel insert

**Fastener Dimensions**

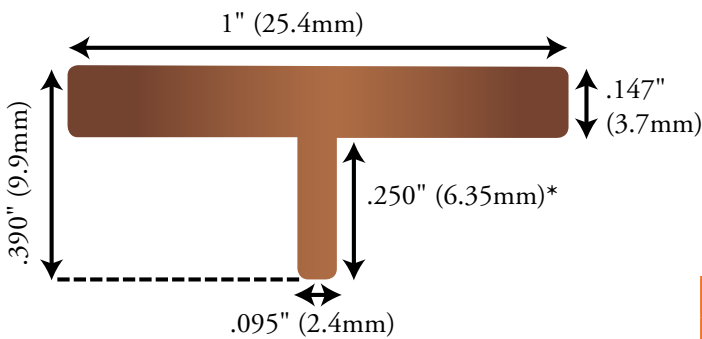

\*Short version shown above  
Tall version = .375" (9.5 mm)

Clip Construction		
Material	Stainless Steel Insert	Available Colors
Polypropylene/ Fiberglass	None	

Decking Compatibility		
Air-Dried Decking	Kiln-Dried Decking	Composite/ PVC Decking
✓	✗	✓

**Allows Contraction on the Width of Air-Dried Lumber**



The method of 45 degree screws hold the decking tight to the joist, while allowing one side of the deck board to remain free to contract.

**Allows Expansion/Contraction Along the Length of Composite/PVC Decking**



Running screws straight down with composite/PVC decking allows these materials to naturally move on their length.



## DeckWise® Standard Installation Specifications

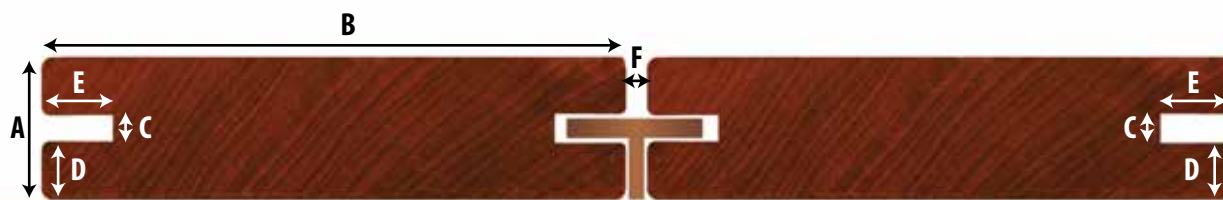

### Board Dimensions

#### Board Thickness

**A\*** = Measurement Of Your Decking

#### Board Width

**B\*\*** = Measurement Of Your Decking

### Groove Dimensions

#### Thickness of Cut

**C** = 5/32" (4mm)

#### Cutting Height

**D\*\*\*** =  $(A - 5/32")/2$

#### Cutting Depth

**E** = 1/2" (13mm)

### Board Spacing

#### During Installation

**F\*\*\*\*** = 3/32" (2,38mm)

\* If using 1-1/2" or thicker material, you may need to upgrade to a longer screw option than what is typically packaged with the fastening kit.

\*\* For decking 8" or wider, the (A) dimension should be at least 1-1/2". Using a wide plank such as this for surface decking will most likely cause cupping issues regardless of how the material is fastened if thicker material is not used.

\*\*\* This formula will create a symmetrical profile that allows you to flip and/or rotate the decking to be able to put the best side up.

\*\*\*\* Fastener automatically achieves correct gap spacing when boards are pushed tight during installation.

### Complete Kit Contains

- (175) IPE CLIP® Standard Hidden Deck Fasteners
- (190) #8x2" Colormatch Black Stainless Steel Star Drive Screws
- (12) 3/8" Tapered Ipe Plugs
- (1) 1/8" High Speed Drill Bit
- (1) T15 Star Drive Tip
- (1) Instruction Sheet

### 100 Ct. Kit Contains

- (100) IPE CLIP® Standard Hidden Deck Fasteners
- (100) #8x2" Colormatch Black Stainless Steel Star Drive Screws
- (1) Instruction Sheet

### 2 Gal. Contractor Bucket

- (525) Hidden Deck Fasteners
- (565) Stainless Steel Deck Screws
- (3) T15 Star Drive Tips
- (3) 1/8" High Speed Drill Bits
- (1) Instruction Sheet

### 5 Gal. Contractor Bucket

- (1050) Hidden Deck Fasteners
- (1130) Stainless Steel Deck Screws
- (5) T15 Star Drive Tips
- (5) 1/8" High Speed Drill Bits
- (1) Instruction Sheet



Coverage varies, see coverage page in this manual.



#8x2" Colormatch Black Stainless Steel Star Drive Screws



3/8" Tapered Ipe Plugs



1/8" High Speed Drill Bit



T15 Star Driver Tip

# Ipe Clip®

Hidden Deck Fasteners

## HIDDEN DECK FASTENER INSTALLATION INSTRUCTIONS

Ipe Clip® products are protected under one or more of the following patents; D485,160; 8,464,488; Other Patents Pending, and/or D470,039 product is licensed under U.S. Patent No. 6,402,415



### STEP 1: Installing the First Deck Board

Apply DeckWise® Joist Tape™ or a bead of exterior adhesive to each joist approximately 3/8" in width. For adhesives, you may want to do this as you go so, that, it does not dry before completion if you have a larger area to install. While adhesive adds hold-down strength to the boards, it does not prevent wood rot. Joist Tape™ prevents joist wood rot as well as seals around deck screws. Even though joists may seem even, changes in weather can cause board movement. Both Joist Tape™ and/or adhesive will also help prevent squeaking from uneven joists in the future.

### STEP 2: Drill a 1/8" Pilot Hole

Use a 1/8" drill bit to pre-drill a pilot hole for the initial face-driven screws. Drill deep enough to penetrate the deck board and NOT the underlying joist material. (All Ipe Clip® Hidden Deck Fastener systems, 175 count and above, include a 1/8" High Speed Drill Bit. We suggest using the 3-in-1 DeckWise® Drill & Drive™ (not included in Ipe Clip® Fastener kits), which has a 1/8" drill bit, 3/8" countersink bit, and screw gun T15 tip that will help speed up this process.)

### STEP 3: Drill a 3/8" Countersink Hole Approximately 3/8" Deep

Use a 3/8" countersink bit to bore a hole approximately 1/4" to 3/8" deep (depending on your deck board thickness) for each screw to be hidden by a hardwood plug. Be sure your countersink bit is sharp and leaves a clean edge.

### STEP 4: Drive a Deck Screw Through the Countersunk Hole

Next, securely drive a deck screw down into the countersunk hole into the joist below. (All Ipe Clip® fastener kits, 175 count and above, have extra stainless steel deck screws included in them for starter boards.) Wood plugs will next be installed into the holes to hide the deck screws and create a smooth, blemish free surface.

### STEP 5: Put a Drop of Glue Into the Countersunk Hole (POLYURETHANE BASED RECOMMENDED)

Place a dab of wood glue (Gorilla Glue® is suggested) into the countersunk hole from the above steps. This will secure the wood plug from popping up in the future. Plus, it will act as a moisture barrier, sealing the countersunk hole and screw.

### STEP 6: Insert a Wood Plug Into Countersunk Hole

Insert a 3/8" tapered (or Extreme ribbed) wood plug and tap it down with a hammer so it fits snug into the hole. Wipe away any excess glue that may squeeze out.

**NOTE:** We always encourage finding the wood grain in the plug and aligning it with the deck board grain. This will help ensure the plug is hidden as much as possible.

### STEP 7: Flush Cut Any Plug Material

Once the plug is hammered in and the glue is dry, remove any excess plug material protruding above the surface of the deck board. You can accomplish this by using a flush cut pull saw, belt sander or an orbital sander with 80 grit sand paper.

### STEP 8: Sand for Hardwood Oil Finish

Sand smooth all areas where a plug was installed so that plug is flush with deck surface. A round, random orbit sander with 80-120 grit sand paper works best. When sanding is finished, we suggest using Ipe Oil™ for a beautiful natural wood color on your entire deck.

### STEP 9: Cut Slots for Ipe Clip® Fasteners

Use a biscuit jointer or a router (with a 5/32" X 1/2" slot cutting bit) to cut a slot in the edge of deck board above each joist. You will want to center this groove in the board so there is a symmetrical profile for best results using the Ipe Clip® Hidden Deck Fasteners by DeckWise®.

**NOTE:** Pre-grooved deck boards are now available from many decking suppliers. If you are using pre-grooved decking, skip this step and proceed to step 10.

## Tools Needed

**ELECTRIC SCREW GUN, BITS & TIPS** - Used to drill pilot holes and for installing the stainless steel screws. (A cordless screwgun with an adjustable clutch is recommended so torque can be properly set to avoid over-tightening of screws.) Use a 1/8" drill bit and a 3/8" countersink bit or the 3-in-1 DeckWise® Drill & Drive™.

**DECKWISE® JOIST TAPE™** - Used to prevent joist wood rot as well as seals around deck screws.

**CAULK GUN & EXTERIOR CONSTRUCTION ADHESIVE** - Used as a leveling agent for uneven joists.

**WOOD GLUE** - Polyurethane based recommended.

**HAMMER** - Used to tap plug into countersunk hole.

### FLUSH CUT PULL SAW, BELT SANDER OR AN ORBITAL SANDER

- A round, random orbit sander with 80-120 grit sand paper works best.

**BISCUIT JOINTER\*** (Common cabinet maker tool, available at most hardware stores & home centers) - Used to make a slot in the edge of the deck boards to allow insertion of the Ipe Clip® fasteners.

**ROUTER\*** Can be used if you do not have access to a biscuit jointer, a #20 biscuit cutting router bit (also called a 5/32" slot cutting bit) will work fine. This method is actually preferred by some installers.

\*Not required for use with pre-grooved decking.

## Made in the USA

All DeckWise® Hidden Deck Fasteners are proudly engineered and manufactured in our US facility.







10

## STEP 10: Predrill a Pilot Hole (FOR HARDWOOD DECKING ONLY.)

Insert one Ipe Clip® fastener into the groove of the deck board above each joist. Where two boards meet on a single joist, only one fastener is needed. Drill a 1/8" pilot hole at a 45° angle for each screw when installing Ipe Clip® fasteners into hardwood decking. You only need to pre-drill through the hardwood. This is to avoid splintering and to make sure the decking is pulled tight to the joist by the screw in the next step.



11A

## STEP 11A: Screwing Ipe Clip® Fasteners (USE (11A) FOR HARDWOOD DECKING.)

Run the stainless steel screws at approximately a 45° angle through the hole in the center of the Ipe Clip® fastener, through the deck board, and down into the joist. It should not take much torque to fasten the deck board. Once the board is snug to the joist you can install the next fastener on the next joist. A screwgun with a clutch setting works great for this as you can turn the clutch down to avoid overdriving screws. Fasten each board using one fastener and one screw per joist. Where two boards meet on a single joist, only one centered fastener is needed at their meeting point.



11B

## STEP 11B: Screwing Ipe Clip® Fasteners (USE (11B) FOR COMPOSITE/PVC DECKING ONLY.)

Run the stainless steel screws straight down through the center of the Ipe Clip® fastener and into the joist. It should not take much torque to fasten the deck board. Once the board is snug to the joist you can install the next fastener on the next joist. A screwgun with a clutch setting works great for this as you can turn the clutch down to avoid overdriving screws. Fasten each board using one fastener and one screw per joist. Where two boards meet on a single joist, only one centered fastener is needed at their meeting point.



12

## STEP 12: Installing the Next Board Over the Exposed Side of the Fastener

Slide the next deck board onto the installed Ipe Clip® fastener protruding from the previous deck board. Again, if pre-grooved decking is not being used, use a biscuit jointer or a router (with a 5/32" X 1/2" slot cutting bit) to cut a slot into the edge of the next deck board above the joist. Keep in mind, this next board will also have Ipe Clip® hidden fasteners installed on it's opposite edge for fastening, and so forth.

**NOTE:** When using Ipe Clip® ExtremeKD™ or Extreme4™ fasteners, use the DeckWise® spacer tools provided to ensure that fastener legs are not crushed while keeping your deck boards tight. Remove spacer tools as soon as any deck board is fastened.

-----Repeat steps 10-12 until all deck boards are installed up to the last board -----



13

## STEP 13: Installing the Last Deck Board

On the last deck board, fastening clips will not be used and it is necessary to fasten the outside edge with surface screws. These surface screws can be concealed by countersinking a 3/8" hole and using the wood plugs supplied. It is also recommended to apply a small amount of construction adhesive on the outside joist for securing the last or outside edge deck boards.

## Recommended Tools and Wood Oil Finish



Using the DeckWise® Drill & Drive™ tool to build your deck makes predrilling, plugging, and driving screws much faster than standard drilling and driving.



## Ipe Oil™

Hardwood Deck Finish

Coat decking with proper deck finish after installation to reduce any wood shrinkage or movement. Ipe Oil™ or similar product is recommended.



DeckWise® Joist Tape™ is a polyethylene waterproof wood flashing using a rubberized asphalt mastic adhesive. Easily apply to decking joists, around deck support posts and over ledger boards.

## Helpful Installation Tips

- If the fastener is tipping down when screw is installed, making the next board difficult to slide on, reinstall the screw to stand it more vertical. The screw should be installed at approximately a 45° to 65° angle.
- Do not over tighten screws. They should be flush or slightly above the surface of the Ipe Clip® fastener.
- Use an end wax on end grain cuts to help prevent checking. Ipe Seal™ or similar product is recommended
- The Hardwood Wrench™ is a self-locking board straightening tool with 1,100 pounds of bending force and works seamlessly with Ipe Clip® Hidden Deck Fasteners to hold deck boards straight while fasteners are being installed.

# Installation: Hardwoods vs Composite/PVC Decking

## Explanation of Hardwood Installation

### Achieve Even Gap Spacing

When DeckWise® hidden deck fasteners are screwed in at a 45° angle, this holds one side of the board in place while forcing all movement from the opposite side. This is the key to maintaining even gap spacing for the life of the deck while still allowing the natural movement of the hardwood. Studies have also shown that the hold-down strength of a screw is greater when it is driven through material at an angle as opposed to straight down. **Hidden fasteners eliminate surface damage such as from face screwing.**



**Shown Above:**  
Ipe (Brazilian Walnut) Hardwood decking installed with DeckWise® Extreme™ hidden deck fasteners.

**Hardwood Decking:** Run screws at a 45° angle.



### Prevent Nail Pops!

Hardwood decking naturally moves on its width as seasons and weather change. This movement rocks the nails (or screws) back and forth, thereby weakening them. This process eventually leads to the nail (or screw head) popping up or worse, the nails (or screws) snapping off completely.



**Nail Pop**

### Protect The Deck Surface

Face screwing deck boards can create many problems after the installation is complete. The surface of the deck is compromised every time a screw penetrates the face of the deck board because this allows water to soak into these exposed holes. This can cause huge problems down the road because the entire integrity of the deck surface is weakened which can cause checking and splitting.



**Wood Rot**

⊘ **Hardwood Decking:** Face screwing is NOT recommended.

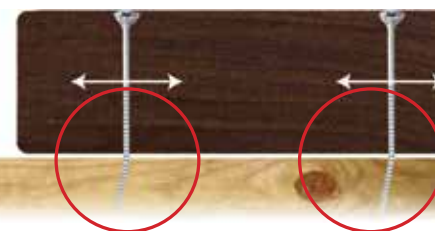
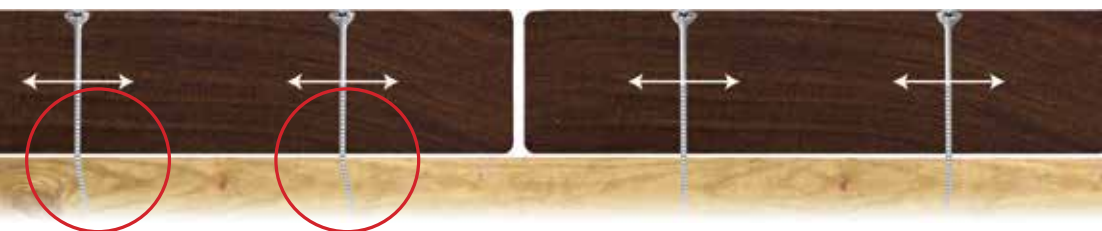

**Shown Above:**  
Ipe (Brazilian Walnut) Hardwood decking installed with face driven screws.

### Prevent Uneven Gap Spacing

Some hidden deck fasteners on the market that run screws straight down, claiming they prevent screws from breaking and weakening. What they fail to reveal is, that, when the hardwood decking naturally moves, nothing is holding the deck boards to the joist. They are free to slide between the fasteners resulting in uneven gap spacing.



**Shown Above:**  
Ipe (Brazilian Walnut) Hardwood decking installed with hidden deck fasteners secured straight down.

⊘ **Hardwood Decking:** Fastening hidden deck fasteners straight down is NOT recommended.



# Installation: Hardwoods vs Composite/PVC Decking

## Explanation of Composite/PVC Installation

### Achieve Even Gap Spacing

The DeckWise® hidden deck fastening system is one that allows you to run the screws straight down when installing composite or PVC decking. This installation technique allows the composite or PVC decking to expand and contract on its length. This is optimal with composite and PVC decking because unlike hardwoods, this material tends to expand on its length rather than width. Since they do not move on their widths like hardwood decking, your gap spacing will be maintained through the life of the product.



*Shown Above:*  
Antique Grey composite decking installed with DeckWise® ExtremeKD™ hidden deck fasteners.

**Composite Decking:** Run screws straight down.



**Composite Decking:** This is a composite deck when viewed from the side... This illustrates the decking expanding on its length.

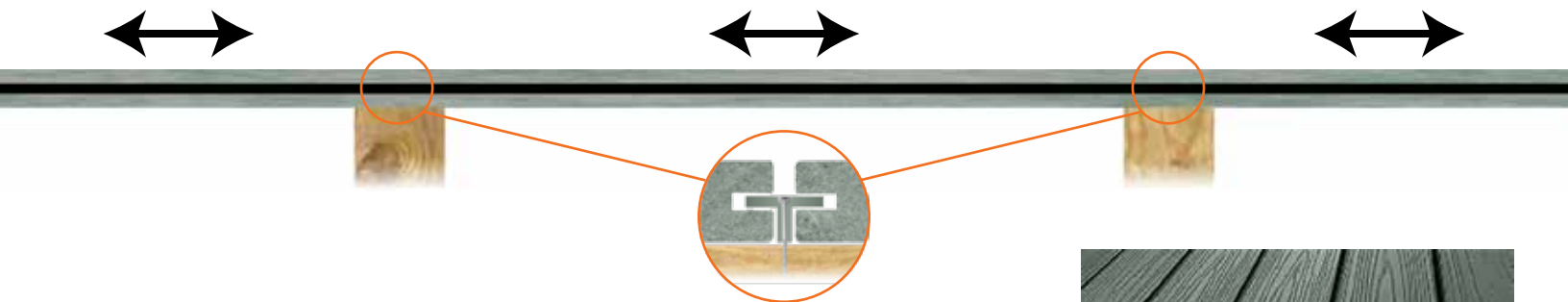

### Prevent Nail Pops and Mushrooming!

Why would you want to blemish your brand new deck surface by running screws through the face of your composite or PVC deck boards during installation? Face screwing this material causes the surface to “mushroom” around the face driven screw. This creates a deck surface that is riddled with unattractive flaws. This method also weakens the screws because, as the composite material naturally expands and contracts, the screws get rocked back and forth and loosen their hold on the joist. This process almost always leads to the screw head popping out or worse, the screw snapping.



*Mushrooming*

*Shown Below:*  
Composite deck as seen from below. This illustrates how the decking moves on its length.

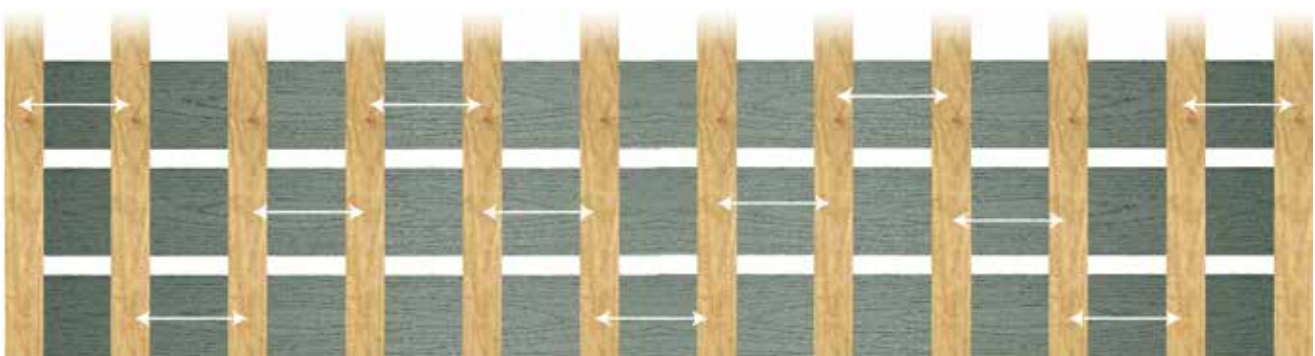

# Board Replacement Step By Step

**STEP 1:** Cut the board that needs to be replaced down the center. If tight, making two cuts can help you remove the center portion of the board more easily.



**Step Hint:**

Use a circular saw to make the two center cuts on the deck board that is to be removed.

**Step-by-step Directions:**

1. Remove the center piece that was cut in the previous step.
2. Remove side sections of board (the side that the screw is running through will have to be pried out).
3. If screw breaks, pound flush into joist with hammer.

**STEP 2:** Remove the cut board and the fastener that was screwed through that board.

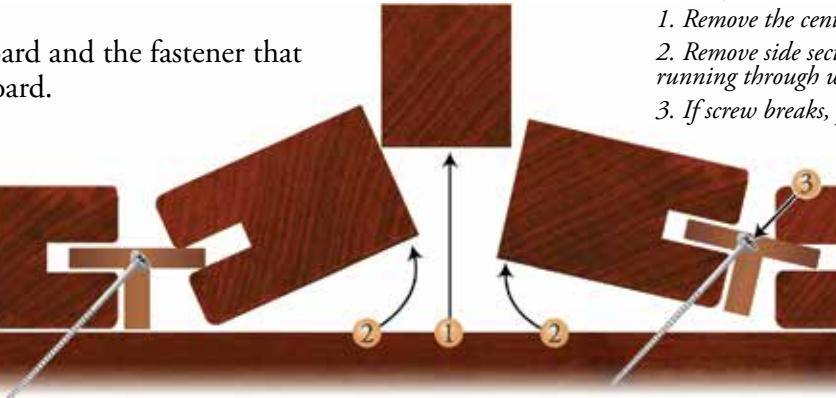

**STEP 3:** Run a screw at a 45° angle into the groove that you removed the DeckWise® fastener from.



**STEP 4:** Carefully slide a new deck board onto the exposed DeckWise® fastener.



**Step Hint:**

Installing a board with a groove on just one side of the deck board is optimal in this step.

**STEP 5:** Countersink a screw straight down into the side of the board that has no fastener and use a wood plug over the hole.

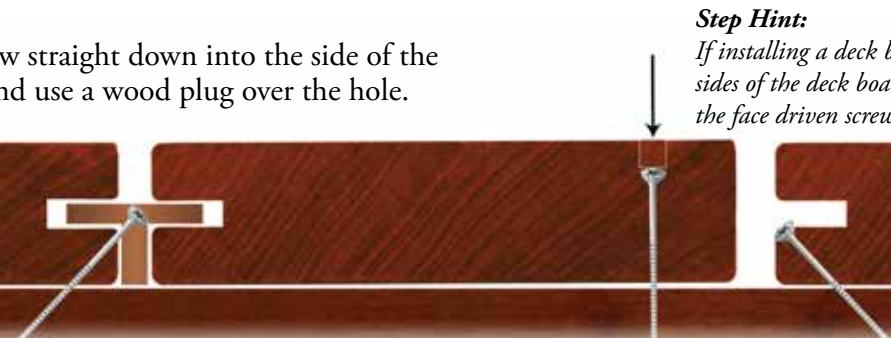

**Step Hint:**

If installing a deck board with grooves on both sides of the deck board, make sure not to drive the face driven screw through the groove.

# Price Comparison

## DeckWise® Hidden Deck Fasteners vs Face Screwing

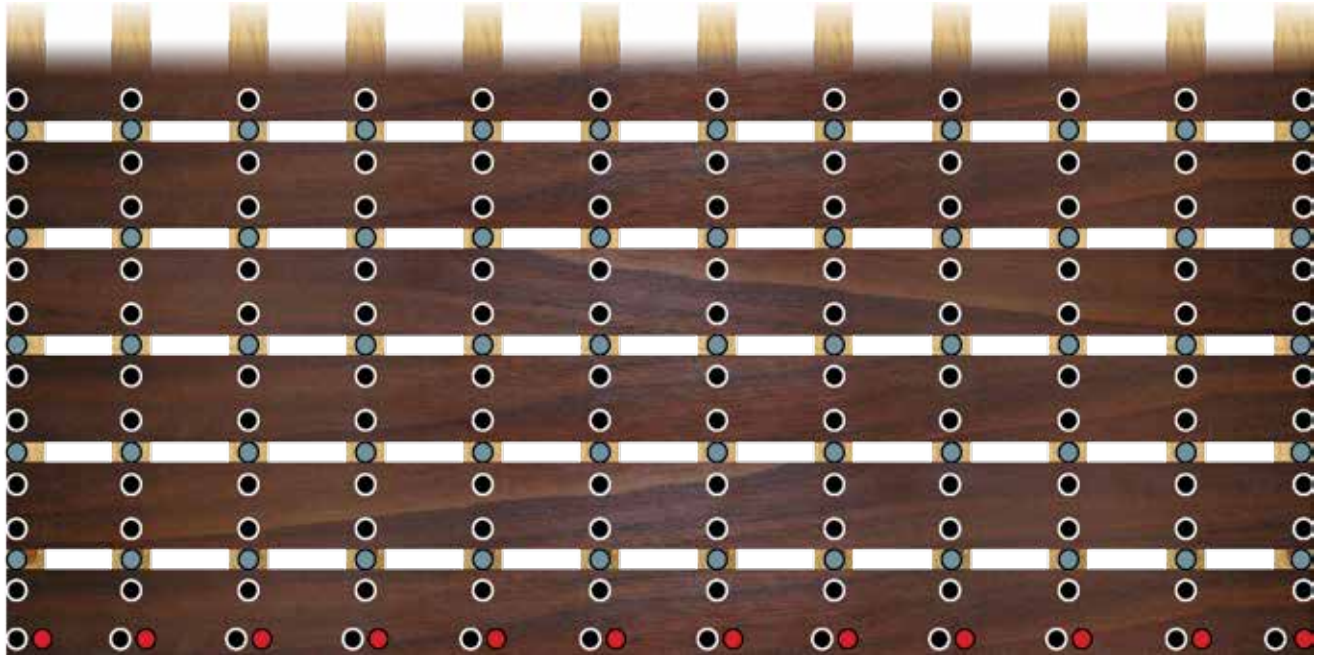

### Face Screwing

Items Needed:  
132 Screws

1 Package Stainless Steel Deck Screws = \$34.42\* (100pcs)

132 - ●Screws = \$45.43

Total = \$45.43

NOTE: Quality and size of deck screws will vary price.

### Standard

Items Needed:  
60 DeckWise® Fasteners  
72 Screws  
12 Plugs

1 DeckWise® Standard fastener kit, screws included= \$96.00 (175pcs)

60 - ●DeckWise® Fasteners & Screws = \$32.91

12 - ●Extra Screws = FREE in kit

12 - ●Plugs = FREE in kit

Total = \$32.91

### Extreme™ ExtremeKD™ or Extreme4™

Items Needed:  
60 DeckWise® Extreme™ Fasteners  
72 Screws  
12 Plugs

1 DeckWise® Extreme™ fastener kit, screws included= \$119.00 (175pcs)

60 - ●DeckWise® Extreme™ Fasteners & Screws = \$40.80

12 - ●Extra Screws = FREE in kit

12 - ●Plugs = FREE in kit

Total = \$40.80

Ipe Hardwood Decking Installed With Ipe Clip® Fasteners

Ipe Hardwood Decking Installed With Face Driven Screws



# Decking System Clip Testing

Preliminary Test Results, 8/25/2010  
 Robb Thomas, Lab Manager  
 Tool Testing Lab, Inc.  
 11180 N. Dixie Dr.  
 Vandalia, OH 45377

## UPLIFT TESTING



### Introduction

*Special clips can be used in decking systems to secure boards to joist. The following clips were fastened to a small joist and pull tested until failure to determine their strength. Each test consisted of fastening a metal board to the frame using 6 clips and the screws provided. A load cell was used to measure the force required to cause the clips to fail. Every test resulted in the screws pulling through the clip at the point in which the screws held them down.*

### Test Data:

Mfg	Model	Shape	Metal Core (Y/N)	Board Spacing (Inches)	Force at Failure (lbs.)
Ipe Clip	EXTREME	Square	Yes	3/32"	1094
Ipe Clip	Standard	Circle	No	3/32"	497.5
Competitor A	Original	Oval	No	3/32"	451.5
Competitor B	Exotic	Rectangle	No	1/4"	322.5

Ashley Laboratories, LTD, 10/1/2010  
 Report #28,674  
 Joshua B. Taylor, C.E.F.  
 10030 Harford Road  
 Baltimore, Maryland 21234

## SALT SPRAY TESTING



**SCOPE:** Salt Spray (Fog) testing pursuant to ASTM B117(09) on 20 parts for 96 hours with evaluations and digital photos every 24 hours.

### RESULTS:

<b>Black Oxide Encased (5 parts)</b>	
<b>Hours</b>	<b>Description</b>
24	No Visible Red Rust (Corrosion)
48	No Visible Red Rust (Corrosion)
72	No Visible Red Rust (Corrosion)
96	No Visible Red Rust (Corrosion)

*These parts meet or exceed the Salt Spray requirements of ASTM A-967 (Stainless Steel) and MIL-DTL-13924 (Black Oxide).*

# Suitability of fasteners for Decking Species & Dryness

Avoid using hidden fasteners with poor quality deck materials with high expansion and contraction rates

Species	Other Names	Dryness	Hidden Fastener			Face Screw
			Extreme™	Extreme4™	ExtremeKD™	
			Extreme™	Extreme4™	ExtremeKD™	ColorMatch Screws
Ipe	Brazilian Walnut, Lapacho, Tabebuia	Air Dried 16 to 20%	YES	YES	NO, wood will shrink and finished gap will be large.	YES
Pine		Kiln or Air Dried	No, wood will shrink off clip.	No, wood will shrink off clip.	No, wood will shrink off clip.	YES
Tigerwood	Muricatara, Goncalo Alves	Kiln Dried 14 to 16%	NO, wood could expand and cause buckling.	YES	YES	YES
		Air Dried	NO, this species should be kiln dried for decking use.	NO, this species should be kiln dried for decking use.	NO, this species should be kiln dried for decking use.	YES, but this species will be unstable unless kiln dried.
Garapa	Brazilian Ash	Kiln Dried	NO, wood could expand and cause buckling.	YES	YES	YES
		Air Dried	NO, this species should be kiln dried for decking use.	NO, this species should be kiln dried for decking use.	NO, this species should be kiln dried for decking use.	YES, but this species will be unstable unless kiln dried.
Massaranduba	Maçaranduba	Kiln Dried 14 to 16%	NO, wood could expand and cause buckling.	YES	YES	YES
Padouk	Padouk, Vermillon	Air Dried	NO, this species should be kiln dried for decking use.	YES	YES	YES
Acacia		Kiln Dried	NO, wood could expand and cause buckling.	YES	YES	YES
Bankirai	Balau	Kiln Dried	NO, wood could expand and cause buckling.	YES	YES	YES
Tatajuba		Kiln Dried	NO, wood could expand and cause buckling.	YES	YES	YES
Merbau		Kiln Dried	NO, wood could expand and cause buckling.	YES	YES	YES

Many other quality species of hardwood decking may be suitable for use with DeckWise® hidden deck fasteners, provided they are properly dried and do not have a high expansion or contraction rate.

Where both Extreme4™ and ExtremeKD™ is a option, it is typically a preference of the size of Gap spacing desired for looks. ExtremeKD™ is a larger Gap.

## STAINLESS STEEL

# TRIM-HEAD

## DECK SCREWS

From DeckWise®

#8

Available in all DeckWise® Hidden Fastener Kits.



#8x3-1/8"

Strength made simple. The DeckWise® brand of stainless decking screws is a great way to ensure hardwood and composite deck boards stick tight to the joist. As part of the DeckWise® line of deck building products, Colormatch screws give builders and DIY homeowners a reliable way to fasten any brand of decking.

DeckWise® Colormatch decking screws are made from high-quality 305 grade stainless steel for optimum performance with hardwoods and composite decking material.

### #8 Stainless Steel Deck Screws For Hardwoods & Thermally Modified Softwoods

- 305 grade stainless steel for optimum performance with hardwoods. (Also available in 316 grade stainless steel. Call for availability.)
- T15 Star Drive finish heads.
- Type 17 auger tips for easy installation.

## Quantities Available:



100



350



1050 &amp; 1750

-  Shadowline Black
-  Hardwood Brown
-  Stainless Steel
-  Cedar
-  Rosy Brown
-  Outdoor Grey

SIZES AVAILABLE	#8x1"	#8x1-1/2"	#8x2"	#8x2-1/2"	#8x3-1/8"
100 COUNT	+	+	+	+	+
350 COUNT	+	+	+	+	+
1050 COUNT	+	+	+	+	+
1750 COUNT	+	+	+	+	+

Exclusive private co-brand labeling programs are available for dealers & distributors on DeckWise® screws, plugs, & spacers.



## STAINLESS STEEL

## BUGLE-HEAD

## DECK SCREWS

From DeckWise®

#10

#10x3-1/8"

#10x2-1/2"



The DeckWise® Bugle Head T25 stainless decking screws are perfect for any patio or deck project including many framing projects. The double countersink flat bugle head has 6 nibs; utilizes a 6 lobe star drive to reduce cam-out and increase torque; and comes as a chipboard thread screw with partial thread and triple spline (one at the beginning on the thread and two at the end of point). Lastly, this screw wields a Type 17 point for ease of wood penetration.

DeckWise® Colormatch #10 decking screws are made from high-quality 305 grade stainless steel for optimum performance with hardwoods, thermally modified softwoods, softwoods and composite decking material.

Quantities Available:



Colormatch your #10 deck screws to your decking material with 4 signature color choices.

#10 Stainless Steel Deck Screws For All Types Of Deck Building Needs



Hardwood Brown



Stainless Steel



Cedar



Outdoor Grey

SIZES AVAILABLE

#10x2-1/2"

#10x3-1/8"

100 COUNT

+

+

350 COUNT

+

+

1050 COUNT

+

+

1750 COUNT

+

+

- 305 grade stainless steel for optimum performance with hardwoods. (Also available in 316 grade stainless steel. Call for availability.)
- T25 Star Drive finish heads.
- Auger tips for easy installation.

# STAINLESS STEEL HEAT-TREATED DECK SCREWS

From DeckWise®

# #8

## Less Stripping, Less Snapping, Less Headaches!

The **NEW** DeckWise® HTSS™ (Heat-Treated Stainless Steel) deck screws offer our specially engineered four-sided tips and a serrated thread design to minimize board splitting or splintering, even when drilling near the edge.

Our HTSS™ deck screws are an 18-8 heat treated screw for hardened

toughness and feature a patented TTAP® T15 Star Drive head with locking bit. Meaning, less stripping, less snapping and less headaches when installing hidden deck fasteners, hidden siding fasteners or face screwing.

Engineered exclusively by DeckWise®, the HTSS™ deck screws make installations easier than ever.

DeckWise® HTSS™ deck screws are available as an option in all DeckWise® Hidden Deck Fastener Kits.

**Perfect for installing Ipe Clip® Hidden Deck Fasteners, Hidden Siding Fasteners and Face Screwing!**

**ttap®** T15 Star Drive Head for less slipping

Heat treated for hardened toughness

Serrated saw threads remove sawdust

Four sided tip for self-drilling



**#8x1-3/4"  
& #8x2"**



DeckWise® HTSS™ are heat treated for hardened toughness and longevity on exotic or thermal wood decking.

Pre-drilling is suggested for quick installations of fasteners including countersinks for face screwing.

We suggest using the DeckWise® Drill & Drive™ tool kit, which comes with 1/8" bits, T15 tips and a 3/8" countersink and is interchangeable with the TTAP® tip.



**LOCKING BIT TO ELIMINATE SLIPPING.**

\* TTAP® is a registered trademark of TtapDrive AS.

SIZES AVAILABLE	#8x1-3/4"	#8x2"
100 COUNT	+	+
350 COUNT	+	+
1050 COUNT	+	+
1750 COUNT	+	+

# SELF-TAPPING METAL JOIST DECK SCREWS

From DeckWise®

# #7

FOR USE WITH STAINLESS STEEL, ALUMINUM  
AND STEEL DECK FRAMING SYSTEMS

More and more these days contractors, architects and DIY deck builders are utilizing metal joist sub-structures to ensure longer-lasting, lower maintenance decks. The DeckWise® Self-Tapping Metal Joist Deck Screw is designed explicitly for metal joist applications.

This handy fastening screw can be used to attach most types of decking materials such as hardwoods, heat treated lumber, soft woods, composite and PVC with aluminum and steel substructures. **Pre-drilling pilot holes through the decking is still recommended.**

This self-drilling auger tip will penetrate metal joists underneath with ease. DeckWise® metal joist deck screws are high performance fasteners, which allow deck builders and architects to provide their customers with uniform and long-lasting clean surfaces when used with our Hidden Deck Fasteners.

These DeckWise® deck screws are available as an option in all DeckWise® Hidden Deck Fastener Kits.

#7x1-5/8"



STAR RECESS AND  
UNDERCUT HEAD:

Deep T-15 star tip recess;  
specially engineered  
head which eliminates  
slipping and stripped  
heads.

TRIPLE STRENGTH  
CORROSION RESISTANCE:

410 stainless steel + Xylan coating  
+ Bright hardening.

DRILL POINT WITH AUGER:

#3 drill point digs into decking material  
with ease and cleanly penetrates the  
decking and underlaying steel or  
aluminum joists.

## Metal Joist Deck Screws

- T15 Star Drive Head for less slipping
- Xylan coated for corrosion resistance
- 410 Stainless Steel for long-lasting
- Auger tip for self-tapping

SIZES AVAILABLE #7x1-5/8"

100 COUNT +

350 COUNT +

1050 COUNT +

1750 COUNT +

## STAINLESS STEEL

COMPOSITE  
DECK SCREWS

From DeckWise®

#10

**One Size  
Available  
#10x2-1/2"**



Hardwood  
Brown



Rosy  
Brown



Cedar



Composite  
Grey



Composite  
Sand

**Five color  
choices to  
match  
the most  
popular  
colors of  
composite  
decking.**

Our 305 Grade Composite screws are made to the same high standards as the DeckWise® products you've come to trust.

These #10 X 2-1/2" Stainless steel bodies are strong and corrosion-resistant. Painted heads, in your choice of Hardwood Brown, Rosy Brown, Cedar, Composite Grey, or Composite Sand match the most popular colors of composite decking.

Advanced auger point and thread design mean these screws perform the way you and your customers need to ensure the highest of quality decking.

Our composite deck screws come with a T20 star head and reverse threads directly below the head which eliminates unsightly "mushrooming" of the composite decking during installation. Dual threads further down compress dust and pull the decking board tight to the joist. All done effortlessly without need of a pre-drilling or countersinking.

T-20 drive delivers plenty of torque without stripping out the heads.

Head designed to eliminate mushrooming or marring of deck surfaces.

These flutes grab the board and hold it tight to the joist.

These threads compress dust deep in the hole, further helping to reduce mushrooming.

These threads grab the joist to hold the board tight to the joist.

Sharp Type 17 auger point cuts fast and clean without splintering or splitting.



## SIZES AVAILABLE #10x2-1/2"

100 COUNT	+
350 COUNT	+
1050 COUNT	+
1750 COUNT	+



# HARDWOOD PLUG KITS & COMPLETE PLUG SYSTEMS

Manufactured By DeckWise®

Quantities Available:



**100      350      1050 & 1750**



When hidden deck fastening is NOT the preferred choice, there's only one complete hardwood plug kit for face screwing in the market. The Master Plug Kit solves the problem by including your choice of four hardwood plug specie (smooth or our ribbed Extreme Plugs™) and the leading brand of wood glue in every kit. The DeckWise® Master Plug Kit fills in the blanks other so-called "complete wood plug kits" leave behind. Finally, builders have the all-in-one system they've been asking for.

## Master Plug Kit

- 350 or 1,050 Hardwood Plugs (choose from Ipe, Cumaru, Tigerwood, Garapa & Massaranduba)
- 1 Complete Drill & Drive™ kit
- 4oz bottle of Gorilla Glue
- 350 or 1,050 DeckWise® #8x2" Stainless Steel Screws



**HARDWOOD PLUGS**  
SMOOTH

SIZE	CUMARU	TIGERWOOD	IPE	MASSARANDUBA
3/8"	+	+	+	+

Tapered design makes installation simple and easy. Available in many different materials to match your decking.



**EXTREME PLUGS™**  
RIBBED

SIZE	CUMARU	TIGERWOOD	IPE	GARAPA	MASSARANDUBA
3/8"	+	+	+	+	+
10MM	+	+	+	+	+
12MM	+	+	+	+	+

PATENT PENDING

Most holes are not drilled perfectly round because the hand held drill wobbles during use creating an oblong hole. The tolerance-absorbing rings that go around each plug fill in these oblong holes and also provides more surface area for glue to hold.

Master Plug Kit includes: Screws, Plugs, Drill & Drive™ Kit, and Gorilla Glue. 350-and 1,050-count kits available.

Custom sizes available for our Hardwood and Extreme Plugs™.



# Ipe Oil™

## Hardwood Deck Finish

Manufactured By DeckWise®



### Beauty:

When deck builders need their hardwood deck to last and maintain its natural beauty, they turn to Ipe Oil™. Our hardwood deck finish seals and preserves exotic hardwoods such as Ipe, Cumaru, Garapa, Tigerwood, Massaranduba, and more.

### Protection:

Ipe Oil™ Hardwood Deck Finish is an oil-based natural wood finish specifically designed for use on exterior hardwood decks. Ipe Oil™ Hardwood Deck Finish provides excellent penetration of even the densest hardwoods with minimal raising of the grain. It protects and conditions the wood while maintaining a completely natural appearance. Ipe Oil™ Hardwood Deck Finish may be used on exterior hardwood to enhance the wood's natural beauty with exceptional results.

### Provides:

- Exceptional Penetration
- Natural Grain Enhancement
- Water Repellency
- UV Barrier Protection
- Reduces Chances of Warps & Cracks

### Product Applications:

- Hardwood Decks
- All Exterior Wood Surfaces
- Fences
- Wood Railings

Approximate Coverage per Gallon\*  
Smooth Wood: 250-300 sq ft / gallon  
Rough Wood: 150-250 sq ft / gallon  
\*Coverage on dense hardwoods



Easy Application, Exceptional Results - *Easy As 1,2,3*

**SHAKE, STIR & MIX WELL • Questions/Comments: [www.DeckWise.com](http://www.DeckWise.com)**

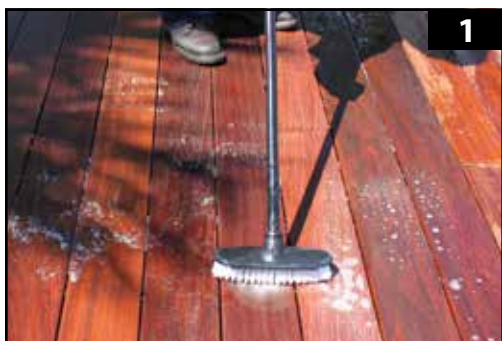

#### STEP ONE:

Clean the deck surface & let dry



#### STEP TWO:

Apply Ipe Oil™ deck finish



#### STEP THREE:

Wipe up any excess Ipe Oil™

**LOW**™  
V.O.C. FORMULA  
Less than 250 grams per liter

**UV Protectant**™

**Specially FORMULATED**™  
For Hardwood Decks

**WITH**™  
Transoxide pigments for added grain enhancement



# Ipe Oil™

Hardwood Deck Finish

Manufactured By DeckWise®



## Limited Liability Warranty

Ipe Oil™ Hardwood Deck Finish is an oil-based natural wood finish specifically designed for use on exterior hardwood decks. DeckWise® offers a limited liability warranty and warrants Ipe Oil™ meets manufacturing standards and specifications. All properly filed warranty claims will be replaced with Ipe Oil™ Hardwood Deck Finish once a claim is approved. This warranty does not cover any damages that may be caused by improper handling, disposal, installation or storage. Claims are only eligible within 12 months after purchase date. No claims for loss of use.

**WARNING: Do not leave rags piled up, they will catch fire or self-combust. Rags, brushes, rollers, steel wool or waste soaked with Ipe Oil™ hardwood Deck Finish may also spontaneously catch fire if improperly discarded. Immediately after each use, place waste materials in a sealed, water-filled metal container. Dispose of empty cans or unused portion in accordance with local, state, and federal regulations.**

Ipe Oil™ deck finish is intended for exterior use only. Use product as directed.

Go to [www.deckwise.com/ipe-oil-label-warning.html](http://www.deckwise.com/ipe-oil-label-warning.html) for complete information.



## Warning!

Our Ipe Oil™ contains linseed oil, which many DIY people and contractors use to stain wood decking, furniture or fences each year. Linseed oil is a natural product extracted out of the flaxseed.

The unique properties of linseed oil is to soak into the grain of wood accentuating the grain giving it a perpetual "wet Look," otherwise known as "popping the grain." Since linseed oil naturally has a yellowish tint, we add a pinch of color to our Ipe Oil™ to improve the natural wood characteristics.

Liquid linseed oil in its container is no more hazardous than any other byproduct oil. The linseed oil by itself is not necessarily the problem. It's the actual petroleum based solvents used to thin the linseed oil that is extremely combustible and flammable.

If a wood finish containing linseed oil is on a cotton rag for application, fire could spontaneously occur at as low as 120 degrees. That's with no external spark. These thinning solvents in the linseed oil can generate heat through exothermic reactions with oxygen.

Rags and other application materials left in a pile, balled up or left unattended are a real problem. As air molecules combine with the linseed oil's solvents, the resulting chemical reaction will accelerate the build up of heat. Since the linseed oil on rags becomes concentrated when in a pile or balled up, this in turn can spontaneously ignite the rag, which the linseed oil's solvents then act as the fuel.

The reason we don't see the finished wood with linseed oil catch fire, is because the linseed oil is spread out. There is no chance for heat to build up, hence, no fire.

Great care must always be taken when using any wood finish containing linseed oil. Always allow application materials to dry completely by laying them flat to dry on a non-flammable surface, out of the sun and heat. The best disposal method is to then place the dry rags in a canister of water and tightly seal the lid before you take it to your local hazardous waste site for disposal.



# Ipe Seal™

## Hardwood End Grain Sealer

Manufactured By DeckWise®

Ipe Seal™ is a wax emulsion sealer proven to increase the structural integrity of hardwood decking. Designed to prevent end checking (drying splits) in freshly sawn logs, lumber, turning blanks, and other exposed wood end and face grain. Ipe Seal™ creates a bond that extends the life of each deck board.

Due to differences in wood species, variety of climatic conditions, and an individuals' usage methods; results are NOT guaranteed.



1 quart covers approx. 500 SF.

Untreated End-Cut

Treated with Ipe Seal™

DO NOT apply to walking surfaces,  
this sealer is very slippery.



**STOP!**

DO NOT apply to walking surfaces!

### Clean Up

Use hot, soapy water on a clean brush. Solvents are NOT recommended.

### Directions

Apply liberally with a brush to all end cuts. (Apply as much as the end grain will hold. If none drips off, it's probably too little. If a lot drips off, it's too much.)

The sooner our sealer is applied to exposed end grain (and face grain of turnings and carvings), the more effective the coating will be. Application is recommended to the wood within 24hrs of cutting.

### Accidental Overexposure

**Inhalation:** Remove to fresh air and consult your physician immediately.

**Eyes:** Flush well with water and consult your physician immediately.

**Ingestion:** Drink 1 quart of water and

### Advisory/Warning

Our End Sealer may cause color or shading changes in wood, depending on species, dryness, handling or other natural variables. Test on ends of sample piece(s) and let stand for 48 hours if this possibility is of concern.

### Safety

- This is a non-hazardous wax emulsion
- Treat it with the same respect as paint
- DO NOT drink
- DO NOT breathe the liquid
- AVOID contact with eyes



see your physician for ingestion of a paraffin wax and water emulsion.

**Skin:** Wash well with soap and water.





# Ipe Seal™

Hardwood End Grain Sealer

Manufactured By DeckWise®

## **NEW!** 5 GALLON BUCKETS

### Ensure your lumber is well taken care of from an early stage!



### End Grain Protection

DeckWise® has made it easier for lumber mills and yards to protect their wood inventory. Now Ipe Seal™ is packaged in a heavy duty 5 gallon plastic pail with a tear-off tab for easier removal of the entire top lid.

Don't let your investment in exotic woods or thermally treated lumber be taken away with unsightly end checking and splitting. Utilize this handy new 5 gallon bucket for those fresh sawn cuts for unmatched protection against the weather.

**STOP!** DO NOT apply to walking surfaces!



## WOOD DECK CLEANER & BRIGHTENER

### DeckWise® Hardwood Cleaner and Brightener

DeckWise® Hardwood and Deck Cleaner and Brightener (Part 1 and 2) concentrated powders are formulated specially to cleanse and brighten exterior wooden decks, wood fences, patios, terraces, wooden log homes, and other outdoor wood building projects.

#### PRODUCT INFO:

- Cleans and brightens outdoor/ exterior wood and removes dirt and graying
- Always cleans before oiling and finish staining of wood surfaces
- Outstanding for all decking maintenance
- Concentrated powders provide maximum strength
- Biodegradable, easy to handle and safe
- Concentrated powders provide maximum strength
- Each 16 oz. container cleans or brightens close to 500 sq. ft.



# HIDDEN SIDING FASTENERS

Manufactured By DeckWise®

Crafted from solid stainless steel, DeckWise® Hidden Siding Fasteners create a smooth, sleek and upscale look. The entire system is designed to significantly reduce cupping, twisting, and mold growth due to water penetration. The DeckWise® Hidden Siding Fastener system is perfect for both residential and commercial applications.



HIDDEN SIDING FASTENERS

STARTER CLIPS

## DeckWise® Hidden Siding Fastener Kit Contains:



DeckWise® Starter Clips



DeckWise® Hidden Siding Fasteners  
U.S. Patent# D663,612 S



#8x2" Stainless Steel Trim Head Screws



T15 Driver Tip

## Available Kit Options:

**50**

HIDDEN SIDING FASTENERS  
50 - #8X2 SCREWS  
1 - T15 TIP

**175**

HIDDEN SIDING FASTENERS  
12 STARTER CLIPS  
190 - #8X2 SCREWS  
1 - T15 TIP

**300**

HIDDEN SIDING FASTENERS  
20 STARTER CLIPS  
325 - #8X2 SCREWS  
2 - T15 TIPS

**1050**

HIDDEN SIDING FASTENERS  
64 STARTER CLIPS  
1130 - #8X2 SCREWS  
3 - T15 TIPS

Install hardwood siding with no visible fasteners on the surface.



**NEW!**

With the addition of a new affixing screw hole, hanging siding vertically, angular and overhead can be a breeze with no worries of loose boards. This new location of the screw penetrates the siding board and secures it to the underlying furring and substructure, allowing all types of new creative designs to become reality!

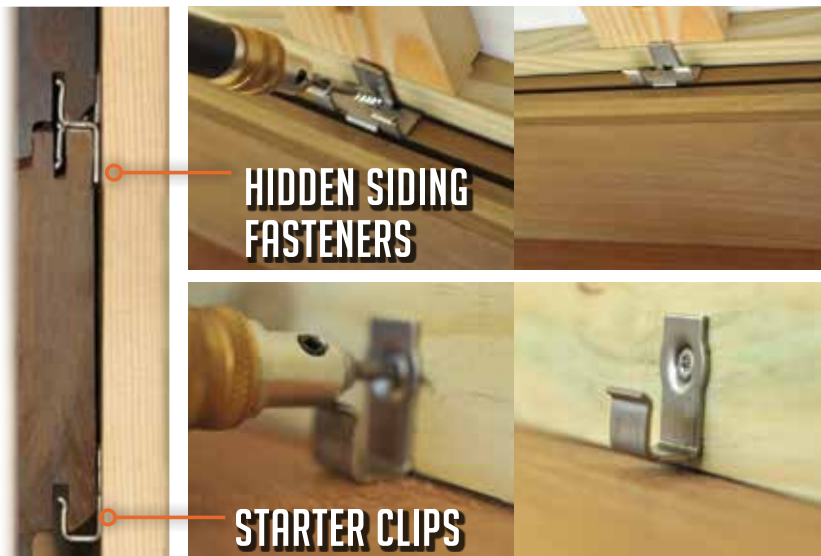

HIDDEN SIDING FASTENERS

STARTER CLIPS



# HIDDEN SIDING FASTENERS

Manufactured By DeckWise®

## Materials needed to install rainscreen siding:

- Rainscreen Siding
- DeckWise® Hidden Siding Fasteners & Starter Clips
- Stainless Steel Screws
- Base Board (1x6 PT Pine is Typical)
- Furring Strips (1x3 Pine is Typical)
- Vapor Barrier
- Level
- Rubber Mallet or Hardwood Wrench™
- Chalk Line
- Cordless Drill
- Ipe Seal™ Hardwood End Grain Sealer
- Eye and Ear Protection, Gloves and Face Mask

## Prior to installation:

- Calculate how much siding you will need based on the “Net Finished Dimensions” only.
- Rainscreen Siding must acclimate to your local climate.
- Use Ipe Seal to cover the ends of the grain of any freshly cut siding boards.

## Step-by-step installation guide:

1. Install house wrap to prevent moisture intrusion. (Always follow the vapor barrier manufacturer’s instructions.)
2. Install the baseboard (horizontal furring strip) with stainless screws. Ensure the baseboard is level.
3. Align furring strips vertically on top of baseboard 16" on center. Attach furring strips.
4. Install starter clips (included with the hidden siding fastener kit) on your baseboard. Align each starter clip with the furring strips installed in step 3. (TIP: use a chalk line reel to create a level line).
5. Install the first Rainscreen Siding board on top of the starter clips. (TIP: Use a level to ensure this first board is aligned properly).
6. Place hidden siding fasteners into the pre-molded groove. Center fastener over vertical furring strips.
7. Drive a stainless steel screw through the siding fastener top hole into the furring strip at a 45 degree angle or, drive a stainless steel screw through the siding fastener bottom hole to penetrate both the siding board and the underlying furring strip, at a 45 degree angle. Pre-drilling is suggested prior to screwing into hardwoods.
8. Set the proceeding siding boards on top of the installed siding fasteners. (TIP: Use a rubber mallet or the Hardwood Wrench™ to align boards properly and straight).
9. Repeat steps 7 & 8, until complete.
10. Install final top board. Pre-drill and counter sink with 3/8" hardwood plugs across the top.

**TIP: Where two pieces of siding butt against each other, use two hidden siding fasteners. (Use two starter clips if there is a butt joint with more than one piece of siding installed on the baseboard).**

Fasten with #8x2" DeckWise® Stainless Steel Deck Screws

DeckWise® Hidden Siding Fastener

Hardwood Siding

House Wrap

1/2" Plywood Wall Sheathing

1" x 4" Pressure Treated Furring Strips

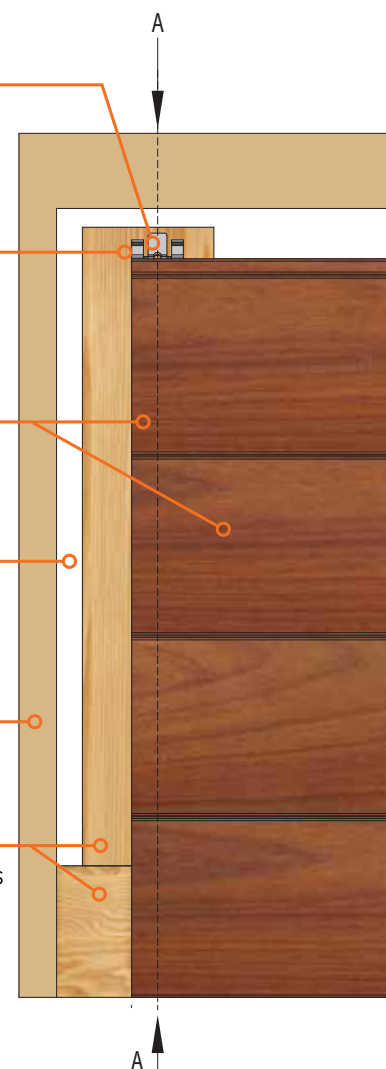

SCREW LOCATION IF HANGING SIDING ON THE VERTICAL, ANGULAR, OR OVERHEAD

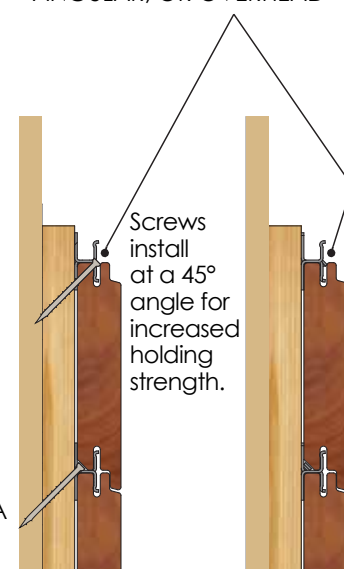

SECTION A-A



# HARDWOOD DECK TILE SYSTEM

From DeckWise®

The DeckWise® Hardwood Deck Tile System and Connectors give Contractors, Architects, DIY Homeowners, and even Renters a quick and easy way to construct semi-permanent decking or to renovate living spaces. The DeckWise® Hardwood

Deck Tile System can be tailored to any specific need or application and are perfect for restaurants, rooftops, patios and bar establishments. Any area where space might be limited or where permanent decking cannot be built.



**IPE: Available in three variations**  
 Smooth surface 24 x 24 with a thickness of 1.69"  
 Smooth surface 20 x 20 with a thickness of 1.18"  
 Anti-Slip surface 20 x 20 with a thickness of 1.18"  
**TIGERWOOD:**  
 Smooth surface 20 x 20 with a thickness of 1.18"  
**CUMARU:**  
 Smooth surface 20 x 20 with a thickness of 1.18"

## HARDWOOD EDGE TRIM FOR DECK TILES

Give deck tile installations a clean, finished look when transitioning to flooring surfaces. Installing hardwood deck tile trim boards will provide a beautiful finished look to any deck tile edge.

Easy to install at the same time deck tiles are laid, or come back later to finish the edges.

Our unique manufacturing process virtually eliminates warping, cracking, and cupping. Deck tile applications demand a durable edge and with this Eased Edge, it is perfect for a gradual decline which allows for smooth transitions.



Straight pieces come with Eased Edge

Corner pieces feature a 45° Miter with an Eased Edge and sold in a pair



**IPE STRAIGHT**

1.5" x 23.875"

**IPE CORNERS**

1.5" x 24" Inside  
27.5" Outside

**CUMARU STRAIGHT**

1.187" x 19.625"

**CUMARU CORNERS**

1" x 19.937" Inside  
23.5" Outside

**TIGERWOOD STRAIGHT**

1.187" x 19.625"

**TIGERWOOD CORNERS**

1" x 19.937" Inside  
23.5" Outside

**IPE STRAIGHT**

1.187" x 19.625"

**IPE CORNERS**

1" x 19.937" Inside  
23.5" Outside

Each Deck Tile Trim piece comes pre-drilled to accept our patented Deck Tile Connectors. An additional 1/4 spacer in the middle will need to be added for support during installation.

# HARDWOOD DECK TILE CONNECTORS

Manufactured By DeckWise®

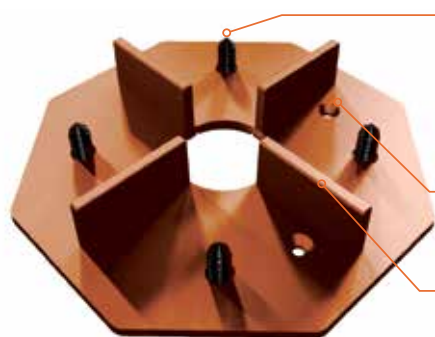

Patented; D665,657

Corner pins secure tile placement.

Elevates the deck tile from the wet subsurface to help prevent wood rot.

Chemical & UV resistant polyethylene.

Pre-drilled countersunk holes for easy fastening into a concrete slab or existing wooden deck.

Preset gap spacing for an even looking surface.

Can be divided into halves or quarters easily with hand tools using the pre-molded score lines.

Center drain hole provides improved drainage for water runoff to prevent pooling in the corners.

Matte texture provides better appearance between gaps.

With the DeckWise® Deck Tile Connector System, you never have to worry about loose or uneven gaps between tiles. Each connector comes with a 3/16 inch spacer for perfect spacing between every deck tile. The Deck Tile Connectors have pre-drilled countersink holes ready for fastening to any existing surface or sub-structure.



Shadowline Black



Hardwood Brown



Concrete Grey

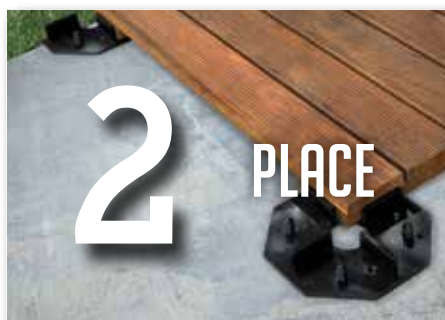

# HARDWOOD

# WRENCH™

Manufactured By DeckWise®



Expandable positions for use on single or double joists up to 3.5 in.

Cam locks in place, holding deck boards straight. Can apply up to 1,100 lbs of pushing force.

Handle is reversible for use from left or right hand direction.

Made from aircraft grade, hard-anodized aluminum with stainless steel components.

Ergonomic hardwood handle.

21"

## VERSATILE DESIGN

The handle and joist pins can be set up standard or reverse, and from left or right hand directions.

**KNURLED JOIST PINS**  
FOR INCREASED GRIPPING



[www.HARDWOODWRENCH.COM](http://www.HARDWOODWRENCH.COM)

U.S. Patent# D623,913 • U.K.# 2,469,964 • E.U.# 10701965.5 • GER.# 202010001036.5 - Other U.S. and International patents pending.

**1 + 10 + 1100** LBS. = **THE ULTIMATE**  
TOOL CONFIGURATIONS BENDING FORCE DECK BOARD STRAIGHTENER



# BITS & TIPS

## DRILL & DRIVE™

### 3-IN-1 DECKING TOOL

Manufactured By DeckWise®



**DRILL**



**FLIP**



**DRIVE**

Use to countersink face screws or for drilling plug holes with pilot holes all in one step.

## EVERY DRILL & DRIVE™ KIT INCLUDES:

- 1 Quick Change Locking Collar
- 2 1/8" High-speed Drill Bit & 3/8" Countersink Tool with T15 Star Drive Tip
- 3 4 5 1/8" Drill Bit & 3/8" Countersink
- 6 On-board Hex Key
- 7 8 9 10 T15 Star Drive Tip



*Replacement tips	T15 Star Drive Tip
*Replacement bits	1/8" (3,175 mm) Drill Bit & 3/8" (9,525 mm) Countersink

\*Sold separately

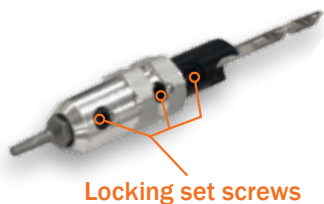



# PERFECT GAPS

# WISE GUIDES

## DECK BOARD SPACERS

Manufactured By DeckWise®

**1/8"**  
**(3,125mm)**



**5/32"**  
**(3,97mm)**



**13/64"**  
**(5,16mm)**



**1/4"**  
**(6,35mm)**



**5/16"**  
**(7,94mm)**



The special blade design of DeckWise® decking spacers prevent denting and marring of hardwood or composite boards when pressed together during installation. Moving laterally in between boards is a breeze thanks to the spacers unique handle.



**20 PACK**



**6 PACK**

(6 Of Any 1 Size)



### Board Gap Spacers

	1/8"	5/32"	13/64"	1/4"	5/16"
6 PACK: 6 OF ANY 1 SIZE	✓	✓	✓	✓	✓
20 PACK: 20 OF ANY 1 SIZE	✓	✓	✓	✓	✓
20 PACK: 4 OF EACH SIZE	✓	✓	✓	✓	✓



# DECKING

# JOIST TAPE

## SELF-ADHESIVE DECK FLASHING & ANTI-CORROSION BARRIER

Manufactured By DeckWise®

### Waterproof Barrier Protection

DeckWise® JOIST TAPE™ is a flexible polyethylene waterproof flashing and barrier material, with a rubberized asphalt mastic adhesive. Simply apply JOIST TAPE™ to tops of joists, around posts and over ledger boards to protect against wood rot and water damage. When applied to the top of joists, around posts, and over ledger boards, DeckWise® Joist Tape™ creates a waterproof membrane that prevents wood rot and decay caused by moisture coming in contact with both treated and untreated lumber.

### Super Grip

DeckWise® Joist Tape™ "Super Grip" rubberized asphalt adhesive self-seals around screws and nails, blocking a primary pathway for water infiltration into deck joists. By blocking moisture and preventing wood rot, DeckWise® Joist Tape™ maximizes the life of your new deck.



## Prevent Wood Rot!

### One Tape Multiple Applications

#### Intended Uses

- Joists
- Posts
- Ledger Boards
- Cut Ends and More!



COMING SOON: POST & LEDGER TAPE

#### Corrosion Blocker

When DeckWise® Joist Tape™ is placed between ACQ, CA-B, or ACZA treated lumber and metal surfaces, such as galvanized metal and aluminum, creating a physical barrier that prevents the corrosion of the metal surface caused by contact with the chemicals in treated lumber.

NOTES



Manufacturers of Hidden Deck Fasteners & Accessories

A large, faint, light grey owl watermark is centered on the page, overlapping the horizontal lines. It has the same stylized appearance as the logo, with orange eyes.

Horizontal lines for writing notes, spanning the width of the page.

**STOP  
SCREWING  
AROUND  
GET INTO THE  
GROOVE!**

# DeckWise<sup>®</sup>.com

MANUFACTURERS OF HIDDEN DECK FASTENERS & ACCESSORIES

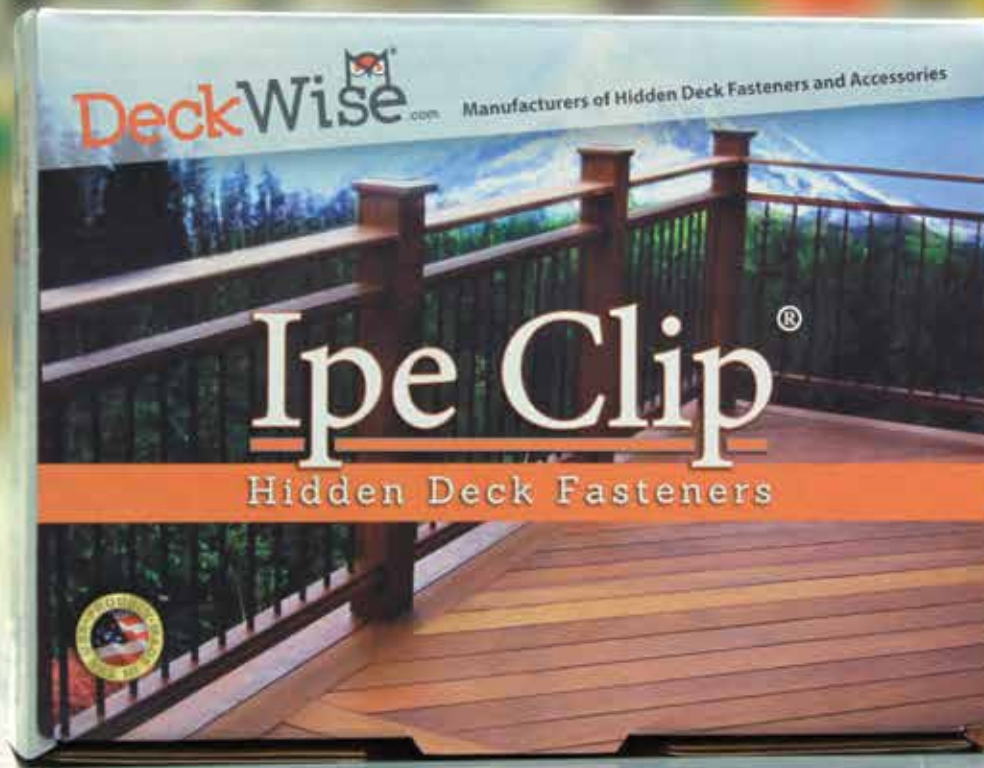

DeckWise<sup>®</sup>.com

© 2015 DeckWise R, The Ipe Clip Fastener Company, LLC. All rights reserved. Ipe Clip is manufactured by DeckWise.

941-896-9851 • [www.DeckWise.com](http://www.DeckWise.com)